

PLEASE READ

This manual is provided as a free service by Projector.com.

We are in no way responsible for the contents of the manual. We do not guarantee its accuracy and we do not make any claim of copyright. The copyright remains the property of their respective owners.

ABOUT PROJECTOR.COM

Projector.com (<http://www.projector.com>) is your review and buying guide resource for DLP and LCD video projectors.

Visit the site to read the latest projector news and reviews, read and comment on projector specifications, download user manuals and much more.

SHARP®

OPERATION MANUAL

MODEL

PG-M10X PG-M10S



ENGLISH

FRANÇAIS

DEUTSCH

ITALIANO

ESPAÑOL

中文

DIGITAL MULTIMEDIA PROJECTOR

Notevision
SLIM & COMPACT PROJECTOR

香港電器安全規格
(國際電工委員會規格適合)

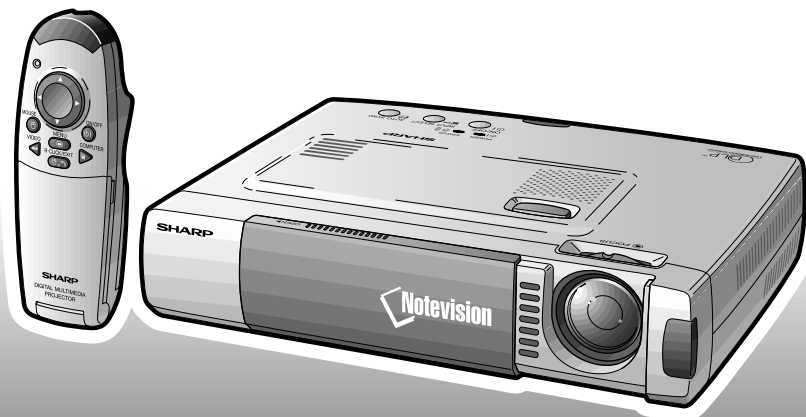

This equipment complies with the requirements of Directives 89/336/EEC and 73/23/EEC as amended by 93/68/EEC.

Dieses Gerät entspricht den Anforderungen der EG-Richtlinien 89/336/EWG und 73/23/EWG mit Änderung 93/68/EWG.

Ce matériel répond aux exigences contenues dans les directives 89/336/CEE et 73/23/CEE modifiées par la directive 93/68/CEE.

Dit apparaat voldoet aan de eisen van de richtlijnen 89/336/EEG en 73/23/EEG, gewijzigd door 93/68/EEG.

Dette udstyr overholder kravene i direktiv nr. 89/336/EEC og 73/23/EEC med tillæg nr. 93/68/EEC.

Quest' apparecchio è conforme ai requisiti delle direttive 89/336/EEC e 73/23/EEC, come emendata dalla direttiva 93/68/EEC.

Η εγκατάσταση αυτή αντακρίνεται στις απαιτήσεις των οδηγιών της Ευρωπαϊκής Ένωσης 89/336/ΕΟΚ και 73/23/ΕΟΚ, όπως οι κανονισμοί αυτοί συμπληρώθηκαν από την οδηγία 93/68/ΕΟΚ.

Este equipamento obedece às exigências das directivas 89/336/CEE e 73/23/CEE, na sua versão corrigida pela directiva 93/68/CEE.



Este aparato satisface las exigencias de las Directivas 89/336/CEE y 73/23/CEE, modificadas por medio de la 93/68/CEE.

Denna utrustning uppfyller kraven enligt riktlinjerna 89/336/EEC och 73/23/EEC så som kompletteras av 93/68/EEC.

Dette produktet oppfyller betingelsene i direktivene 89/336/EEC og 73/23/EEC i endringen 93/68/EEC.

Tämä laite täyttää direktiivien 89/336/EEC ja 73/23/EEC vaatimukset, joita on muutettu direktiivillä 93/68/EEC.

SPECIAL NOTE FOR USERS IN THE U.K.

The mains lead of this product is fitted with a non-rewireable (moulded) plug incorporating a 13A fuse. Should the fuse need to be replaced, a BSI or ASTA approved BS 1362 fuse marked  or  and of the same rating as above, which is also indicated on the pin face of the plug, must be used.

Always refit the fuse cover after replacing the fuse. Never use the plug without the fuse cover fitted.

In the unlikely event of the socket outlet in your home not being compatible with the plug supplied, cut off the mains plug and fit an appropriate type.

DANGER:

The fuse from the cut-off plug should be removed and the cut-off plug destroyed immediately and disposed of in a safe manner.

Under no circumstances should the cut-off plug be inserted elsewhere into a 13A socket outlet, as a serious electric shock may occur.

To fit an appropriate plug to the mains lead, follow the instructions below:

IMPORTANT:

The wires in the mains lead are coloured in accordance with the following code:

Blue: Neutral

Brown: Live

As the colours of the wires in the mains lead of this product may not correspond with the coloured markings identifying the terminals in your plug, proceed as follows:

- The wire which is coloured blue must be connected to the plug terminal which is marked N or coloured black.
- The wire which is coloured brown must be connected to the plug terminal which is marked L or coloured red.

Ensure that neither the brown nor the blue wire is connected to the earth terminal in your three-pin plug.

Before replacing the plug cover make sure that:

- If the new fitted plug contains a fuse, its value is the same as that removed from the cut-off plug.
- The cord grip is clamped over the sheath of the mains lead, and not simply over the lead wires.

IF YOU HAVE ANY DOUBT, CONSULT A QUALIFIED ELECTRICIAN.

Before using the projector, please read this operation manual carefully.

OPERATION MANUAL

ENGLISH

ENGLISH

IMPORTANT

For your assistance in reporting the loss or theft of your projector, please record the Serial Number located on the bottom of the projector and retain this information. Before recycling the packaging, please be sure that you have checked the contents of the carton thoroughly against the list of "Supplied Accessories" on page 8.

Model No.: PG-M10X
Serial No.:

Model No.: PG-M10S
Serial No.:

There are two important reasons for prompt warranty registration of your new SHARP Projector, using the REGISTRATION CARD packed with the projector.

1. WARRANTY

This is to assure that you immediately receive the full benefit of the parts, service and labor warranty applicable to your purchase.

2. CONSUMER PRODUCT SAFETY ACT



To ensure that you will promptly receive any safety notification of inspection, modification, or recall that SHARP may be required to give under the 1972 Consumer Product Safety Act, PLEASE READ CAREFULLY THE IMPORTANT "LIMITED WARRANTY" CLAUSE.

U.S.A. ONLY

WARNING: High brightness light source. Do not stare into the beam of light, or view directly. Be especially careful that children do not stare directly into the beam of light.



WARNING: To reduce the risk of fire or electric shock, do not expose this product to rain or moisture.

	CAUTION RISK OF ELECTRIC SHOCK. DO NOT REMOVE SCREWS EXCEPT SPECIFIED USER SERVICE SCREW.	
CAUTION: TO REDUCE THE RISK OF ELECTRIC SHOCK, DO NOT REMOVE COVER. NO USER-SERVICEABLE PARTS EXCEPT LAMP UNIT. REFER SERVICING TO QUALIFIED SERVICE PERSONNEL.		



The lightning flash with arrowhead symbol, within an equilateral triangle, is intended to alert the user to the presence of uninsulated "dangerous voltage" within the product's enclosure that may be of sufficient magnitude to constitute a risk or electric shock to persons.



The exclamation point within a triangle is intended to alert the user to the presence of important operating and maintenance (servicing) instructions in the literature accompanying the product.

WARNING: FCC Regulations state that any unauthorized changes or modifications to this equipment not expressly approved by the manufacturer could void the user's authority to operate this equipment.

U.S.A. ONLY

INFORMATION

This equipment has been tested and found to comply with the limits for a Class A digital device, pursuant to Part 15 of the FCC Rules. These limits are designed to provide reasonable protection against harmful interference when the equipment is operated in a commercial environment. This equipment generates, uses, and can radiate radio frequency energy and, if not installed and used in accordance with the operation manual, may cause harmful interference to radio communications. Operation of this equipment in a residential area is likely to cause harmful interference, in which case the user will be required to correct the interference at his own expense.

U.S.A. ONLY

The enclosed computer cable must be used with the device. The cable is provided to ensure that the device complies with FCC Class A verification.

U.S.A. ONLY



WARNING:

This is a class A product. In a domestic environment this product may cause radio interference in which case the user may be required to take adequate measures.

WARNING:

The cooling fan in this projector continues to run for about 90 seconds after the projector is turned off. During normal operation, when turning the power off always use the **POWER ON/OFF** button on the projector or the remote control. Ensure the cooling fan has stopped before disconnecting the power cord.

DURING NORMAL OPERATION, NEVER TURN THE PROJECTOR OFF BY DISCONNECTING THE POWER CORD. FAILURE TO OBSERVE THIS WILL RESULT IN PREMATURE LAMP FAILURE.

Caution Concerning the Lamp Replacement

See "Replacing the Projection Lamp" on page 37.

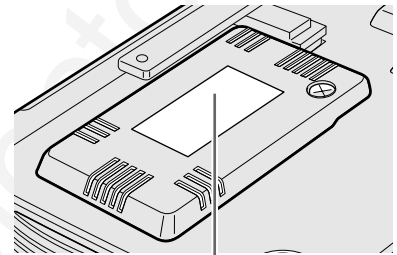

▲ CAUTION HOT SURFACE. REPLACE WITH SAME SHARP LAMP UNIT TYPE BQC-PGM10X/1 ONLY. UV RADIATION : CAN CAUSE EYE DAMAGE. TURN OFF LAMP BEFORE SERVICING. MEDIUM PRESSURE LAMP : RISK OF EXPLOSION. POTENTIAL HAZARD OF GLASS PARTICLES IF LAMP HAS RUPTURED. HANDLE WITH CARE. SEE OPERATION MANUAL.

▲ ATTENTION SURFACE CHAUDE. NE REMPLACER QUE PAR UNE UNITE DE LAMPE SHARP DE TYPE BQC-PMG10X/1. RAYONS ULTRAVIOLETS : PEUVENT ENDOMMAGER LES YEUX. ETEINDRE LA LAMPE AVANT DE PROCEDER A L'ENTRETIEN. LAMPE A MOYENNE PRESSION : RISQUE D'EXPLOSION. DANGER POTENTIEL DE PARTICULES DE VERRE EN CAS DE RUPTURE DE LA LAMPE. A MANIPULER AVEC PRECAUTION, SE REPORTER AU MODE D'EMPLOI.

For Netherlands Only

Bij dit product zijn batterijen geleverd. Wanneer deze leeg zijn, moet u ze niet weggooien maar inleveren als KCA.





IMPORTANT SAFEGUARDS



Electrical energy can perform many useful functions. This product has been engineered and manufactured to ensure your personal safety. However, IMPROPER USE CAN RESULT IN POTENTIAL ELECTRICAL SHOCK OR FIRE HAZARD. In order not to defeat the safeguards incorporated into this Projector, observe the following basic rules for its installation, use and servicing. For your own protection and reliable usage of your projector, please be sure to read these "IMPORTANT SAFEGUARDS" carefully before use.

1. Read Instructions

All the safety and operating instructions should be read before the product is operated.

2. Retain Instructions

The safety and operating instructions should be retained for future reference.

3. Heed Warnings

All warnings on the product and in the operating instructions should be adhered to.

4. Follow Instructions

All operating and use instructions should be followed.

5. Cleaning

- Unplug this product from the wall outlet before cleaning. Do not use liquid cleaners or aerosol cleaners. Use a damp cloth for cleaning.
- Never use strong detergents or solvents such as alcohol or thinner.
- Use a blower or lens paper to clean the lens, and be careful not to scratch or mar the lens.

6. Attachments

Do not use attachments not recommended by the product manufacturer as they may cause hazards.

7. Water and Moisture

Do not use this product near water—for example, near a bathtub, wash bowl, kitchen sink, or laundry tub; in a wet basement; or near a swimming pool; and the like.

8. Accessories

Do not place this product on an unstable cart, stand, tripod, bracket, or table. The product may fall, causing serious injury to a child or adult, and serious damage to the product. Use only with a cart, stand, tripod, bracket, or table recommended by the manufacturer, or sold with the product. Any mounting of the product should follow the manufacturer's instructions, and should use a mounting accessory recommended by the manufacturer.

9. Transportation

A product and cart combination should be moved with care. Quick stops, excessive force, and uneven surfaces may cause the product and cart combination to overturn.



10. Ventilation

Slots and openings in the cabinet are provided for ventilation to ensure reliable operation of the product and to protect it from overheating. The openings should never be covered or blocked by placing the product on a bed, sofa, rug, or other similar surface. This product should not be placed in a built-in installation such as a bookcase or rack unless proper ventilation is provided or the manufacturer's instructions have been adhered to.

11. Power Sources

This product should be operated only from the type of power source indicated on the marking label. If you are not sure of the type of power supply to your home, consult your product dealer or local power company. For products intended to operate from battery power, or other sources, refer to the operating instructions.

12. Grounding or Polarization

This product is provided with one of the following types of plugs. If the plug should fail to fit into the power outlet, please contact your electrician.

Do not defeat the safety purpose of the plug.

- a. Two-wire type (mains) plug.
- b. Three-wire grounding type (mains) plug with a grounding terminal.

This plug will only fit into a grounding type power outlet.

13. Power-Cord Protection

Power-supply cords should be routed so that they are not likely to be walked on or pinched by items placed upon or against them, paying particular attention to cords at plugs, convenience receptacles, and the point where they exit from the product.

14. Lightning

For added protection for this product during a lightning storm, or when it is left unattended and unused for long periods of time, unplug it from the wall outlet and disconnect the power cord. This will prevent damage to the product due to lightning and power-line surges.

15. Overloading

Do not overload wall outlets, extension cords, or integral convenience receptacles as this can result in a risk of fire or electric shock.

16. Object and Liquid Entry

Never push objects of any kind into this product through openings as they may touch dangerous voltage points or short-out parts that could result in a fire or electric shock. Never spill liquid of any kind on the product.

17. Servicing

Do not attempt to service this product yourself as opening or removing covers may expose you to dangerous voltage or other hazards. Refer all servicing to qualified service personnel.

18. Damage Requiring Service

Unplug this product from the wall outlet and refer servicing to qualified service personnel under the following conditions:

- a. If the power-supply cord or plug is damaged.
- b. If liquid has been spilled, or objects have fallen into the product.
- c. If the product has been exposed to rain or water.
- d. If the product does not operate normally by following the operating instructions. Adjust only those controls that are covered by the operating instructions, as an improper adjustment of other controls may result in damage and will often require extensive work by a qualified technician to restore the product to normal operation.
- e. If the product has been dropped or damaged in any way.
- f. If the product exhibits a distinct change in performance, this indicates a need for service.

19. Replacement Parts

When replacement parts are required, be sure the service technician has used replacement parts specified by the manufacturer or with the same characteristics as the original part. Unauthorized substitutions may result in fire, electric shock, or other hazards.

20. Safety Check

Upon completion of any service or repairs to this product, ask the service technician to perform safety checks to determine that the product is in proper operating condition.

21. Heat

This product should be situated away from heat sources such as radiators, heat registers, stoves, or other products (including amplifiers) that produce heat.



IMPORTANT SAFEGUARDS

Installation

- For best results, use the product in a darkened room.
- Place the product on a flat, level surface in a dry area away from dust and moisture.
- Do not place the product in direct sunlight, near heaters or heat radiating appliances.
- Exposure to direct sunlight, smoke or steam can harm internal components.
- Handle the product carefully. Dropping or jarring can damage internal components.
- Do not place heavy objects on top of the product.

Power Supply

- The product is designed to operate on a power supply of 110 to 120 and 220 to 240 V 50/60 Hz AC. Ensure that your power supply fits these requirements before attempting to use the unit.
- For PLUGGABLE EQUIPMENT, the socket-outlet shall be installed near the equipment and shall be accessible.
- Disconnect the power code (mains lead) from the power outlet after using the product.
Before disconnecting the power code, make sure the POWER indicator lamp is orange and not flashing.
- Handle the power code carefully and avoid excessive bending. A damaged cord can cause electric shock or fire.

Lamp Replacement

- Be sure to replace the lamp when the STATUS indicator comes on. If you continue to use the lamp after 1,100 hours of usage, the lamp will turn off (See page 37).

Fire and Shock Precautions

- Ensure that there is sufficient ventilation and that vents are unobstructed to prevent the buildup of heat inside the product. Allow at least 20 cm (7 7/8 inches) of space between the unit and surrounding obstructions.
- Prevent foreign objects such as paper clips and bits of paper from falling into the product. Do not attempt to retrieve any objects that fell into the product. Do not insert any metal objects such as a wire or screwdriver into the product. If something should fall into the product, immediately disconnect the power cable from the product and have the object removed by a Sharp Authorized LCD Projector Dealer or Service Center.
- Do not place any liquids on top of the product.
- **Do not look into the lens while the product is on. Serious damage to your eyes could result.**



Contents

Basic Information & Preparations

Important Safeguards	3
Usage Guidelines	6
For SHARP Assistance (U.S.A. only)	6
Features	7
Supplied Accessories	8
Preparing the Remote Control	9
Inserting the batteries	9
Remote control effective range	9
Part Names	10
Installation	13

Connections

Connections	15
Connecting video equipment	15
Connecting Video Equipment With Component	
Video Signal (YPbPr) Output	16
Connecting a PC or Macintosh	16
Changing the computer's video resolutions	17
Notebook computers and resolution standards ...	17
Receiving Video Output from Personal Computers ...	17

Basic Operation

Using the unit	18
Using the Remote Control (Input Selection)..	20
Using the Remote Control as the PC Mouse .	21
Various functions while using the unit	22
Automatic Screen Adjustment	22
Freezing animated images	22
Turning off the image and muting the sound	
temporarily	22
Adjusting the Volume	22
KEYSTONE Adjustment	22
Enlarging the picture	23
Screen Reduction	23

Menu Operation

Menu operation	24
Menu Structure	24
Adjusting the picture elements	26
Adjusting the projected image from the	
 computer	27
Manual Adjustment of Personal Computer	
Images	28
Adjusting Clock Frequency and Phase	28
Adjusting the position of the image	28

Resetting	29
Resetting the factory defaults	29
Resetting the Lamp Usage Timer	29
Advanced Menu Settings	30
Set the colors as desired in accordance with the	
image contents.	30
Adjusting Color Balance	30
Setting the Video Type	30
Selecting the Color System	30
Setting in Accordance with Image Content ...	31
Setting the COMPUTER input terminal	31
Setting the Display Frame	31
Setting Filter	31
Initial Settings	32
Setting Keystone	32
Setting the partial display position	32
Audio Muting	32
Selecting the Background	32
Auto Gain	32
Auto Source Settings	33
Selecting a Projection Format	33
Using the Power Saving Function	33
Setting the Menu (Option)	34
Selecting the Menu Language	34
Setting the Menu Display Position	34
Menu Viewing Settings	34
Other Menu Settings	34
On-screen Display	34

Others

Troubleshooting	35
When the STATUS Indicator Illuminates or	
 Flashes	36
Replacing the Projection Lamp	37
Transporting the Projector	38
Specifications	39

Appendix

Guide to Effective Presentations	41
Glossary	45
Index	46



Usage Guidelines

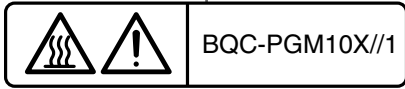
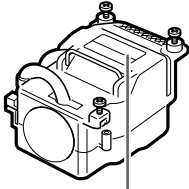

Caution Concerning the Lamp Unit

Potential hazard of glass particles if lamp has ruptured. Please have Sharp Authorized LCD Projector Dealer or Service Center replace lamp if rupture occurs.

See "Replacing the Projection Lamp" on page 37.

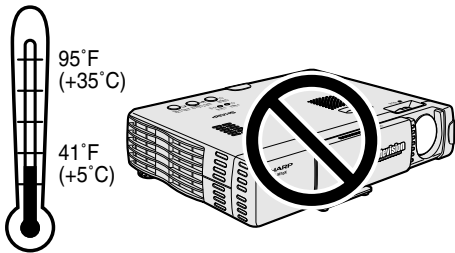

Cautions Concerning the Setup of the Projector

For minimal servicing and to maintain high image quality, SHARP recommends that this projector be installed in an area free from humidity, dust and cigarette smoke. If the projector is used in these environments, the lens will need to be cleaned more often, and internal cleaning may become necessary. As long as the projector is regularly cleaned, use in these environments will not reduce the overall operation life of the unit. Internal cleaning should only be performed by a Sharp Authorized LCD Projector Dealer or Service Center.

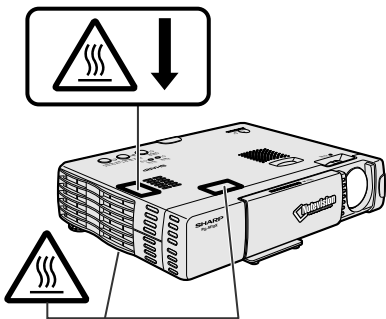

Notes on Operation

- The three marks shown on the left are caution labels for parts of the projector that emit intense heat during operation.
- The cooling fan (exhaust vent), the lamp cage cover and adjacent areas may be extremely hot during projector operation. To prevent injury, do not touch these areas until they have sufficiently cooled.
- Allow at least 10 cm (3 ¹⁵/₁₆ inches) of space between the cooling fan (exhaust vents) and the nearest wall or obstruction.
- If the cooling fan becomes obstructed, a protection device will automatically turn off the projector lamp. This does not indicate a malfunction. Remove the projector power cord from the wall outlet and wait until the projector has sufficiently cooled. Then turn on the power by plugging the power cord back in. This will return the projector to the normal operating condition.

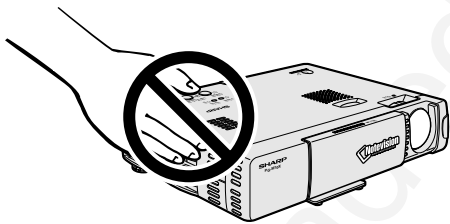

For SHARP Assistance (U.S.A. only)

If you encounter any problems during setup or operation of this projector, first refer to the "Troubleshooting" section on page 35. If this operation manual does not answer your question, please call toll free 1-888-GO-SHARP (1-888-467-4277) for further assistance. Or, send us an e-mail at lcdsupport@sharpsec.com.

Our World Wide Web address is <http://www.sharp-usa.com/>.



Congratulations On Your Purchase Of The PG-M10X/PG-M10S Digital Multimedia Projector

The PG-M10X/PG-M10S is one of the smallest data projectors available today. Although small in size, the unit allows you to project precise images up to 200 inches (measured diagonally) from your PC or Macintosh desktop or notebook computer, VCR, document camera, laser disc player, DVD player, etc.

The unit can be operated from a standard table top. The unit can also be used to project images from behind the screen.

Main Features You'll Enjoy

- **Compatible with following various color systems:**

- NTSC (U.S. and Canada standard)
- NTSC4.43 (Middle East standard)
- PAL (Western Europe standard)
- PAL-M (Brazil standard)
- PAL-N (Argentina standard)
- PAL (60 Hz)
- SECAM (France and Eastern Europe standard)

- **(PG-M10X)**

Small size, and weighing only 1.4 kg (3.1 lbs.)

- **(PG-M10S)**

Small size, and weighing only 1.4 kg (3.1 lbs.)

Using Digital Micromirror Device™ (DMD™) by Texas Instruments we have developed an efficient design to improve light output efficiency. With this improvement, we can better reproduce the three basic colors (RGB) required for color reproduction on a single DMD. This results in superior brightness, smaller size and lighter weight.

- **Sharp, clear images**

There is no RGB color separation, and the spaces between the individual pixels are not noticeable. That means sharp and clear reproduction of small characters and figures. Take a closer look and notice the difference in quality!

- **Outstanding sharp, clear, 3D like images with vivid colors when reproducing DVD video and other high picture-quality data/video sources**

Accurate gray scale reproduction makes for more natural image displays. DVD and other high quality image sources bring out the true image display quality of the unit.

- **Screen not distorted to a trapezoid (keystoning) when projecting to the height of the line of vision**

Because the projection position is already set to the height of the line of vision, there is no keystoning effect. Even when projecting above or under the height of the line of vision, image distortion (if any) can be adjusted using the keystone correction function.

- **(PG-M10X)**

Fully compatible with true XGA; support for SXGA using advanced intelligent compression technology

The advanced intelligent compression technology enables these projectors to present clear compression SXGA images without any line omission.

- **(PG-M10S)**

Fully compatible with true SVGA; support for XGA using advanced intelligent compression technology

The advanced intelligent compression technology enables it to present clear compression XGA images without any line omission.

- **A remote control that can operate the PC**

The supplied remote control both operates the unit and acts as a wireless mouse control to operate the PC connected to the unit. The wireless mouse control is available when the unit is connected to USB or PS/2 port of the personal computer.

- **The compact and easy to carry cabinet with its contemporary design compliments any office, boardroom, or auditorium.**

Supplied Accessories

Make sure your box contains everything listed below*. If any pieces are missing, contact your dealer. Please save the original box and packing materials in case you need to ship the unit.

For remote control

Remote control



Batteries (size AAA/R03)

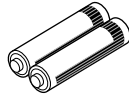

For video equipment connection

Video cable

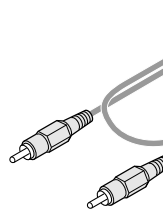

S-video cable
(4 PIN DIN CABLE)

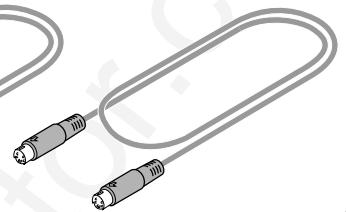

Power cord

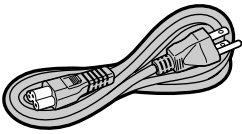

(1) For Americas

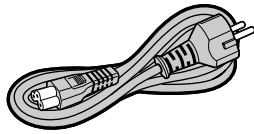

(2) For Europe, except U.K.

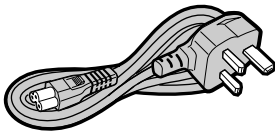

(3) For U.K., Hong Kong and Singapore

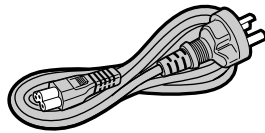

(4) For Australia, New Zealand and Oceania

NOTE

*For Americas Customers: (1)

The projector includes one AC power cord suitable for Americas.

*For Customers other than Americas: (2),(3),(4)

The projector includes three AC power cords suitable for countries other than Americas. Use the AC power cord that corresponds to the wall outlet in your country.

When using the remote control as computer mouse

USB mouse control cable

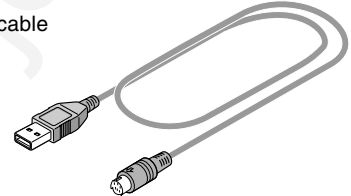

PS/2 mouse control cable
(9 PIN DIN CABLE)

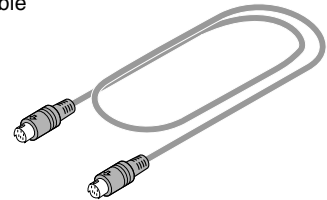

Soft pouch

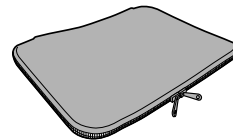

For computer connection

Computer RGB cable

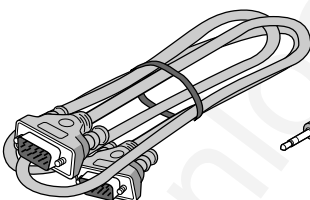

Audio cable

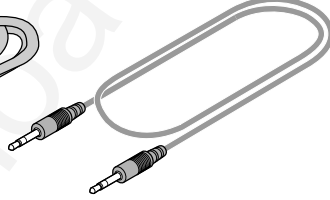

Audio adaptor
(mini-jack pin conversion)

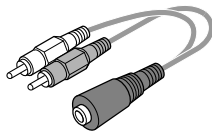

Carrying bag



- Projector Operation Manual
- Projector Quick Reference Guide



Preparing the Remote Control



Inserting the batteries

- 1 Press firmly and slide the battery cover off.

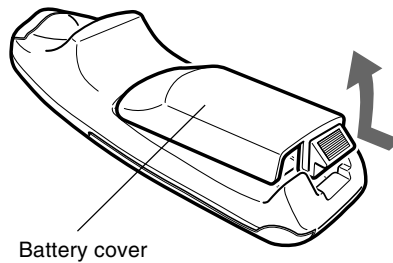

- 2 Insert the two supplied batteries (size AAA/R03). Ensure that the polarities (+ and -) of the batteries are aligned correctly.

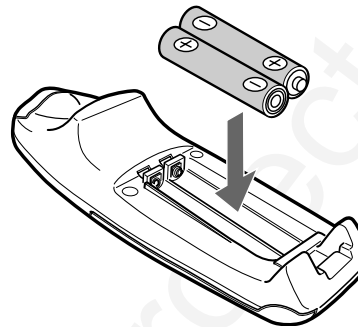

- 3 Slide the battery cover back until it snaps into place.

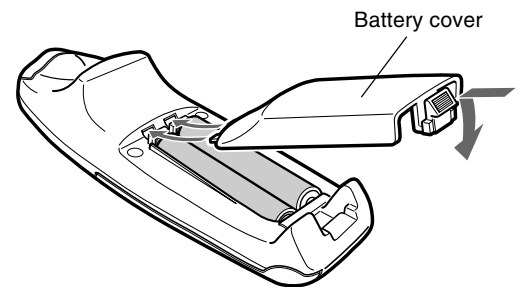

NOTE

- If the remote control gets wet, wipe it dry immediately.
- Avoid excessive heat and humidity.
- If you will not be using the remote control for a long time, remove the batteries.
- Do not mix new and old or different types of batteries.
- There are operations that can only be carried out by remote control. Handle the remote control carefully.

Remote control effective range

The remote control sensors are located on the front and back of the unit.

The controllable range is 50 degrees horizontally and 30 degrees vertically relative to a line that is at a right angle to the remote control sensor. The working distance between the remote control and the unit's remote control sensor is limited to 4 meters (157 1/2").

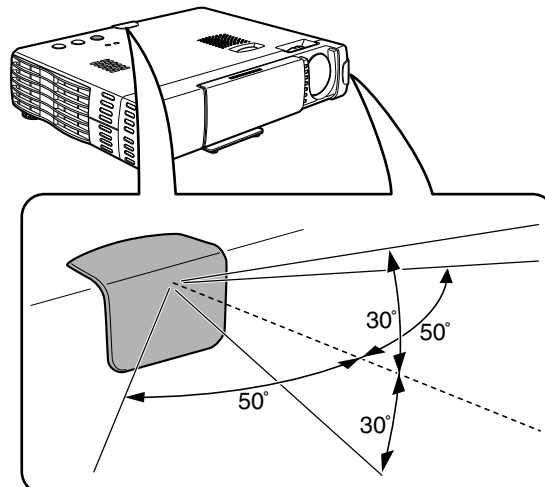

Part Names

Numbers next to the part names refer to the main pages in this manual where the topic is explained.

Top, front side panel view

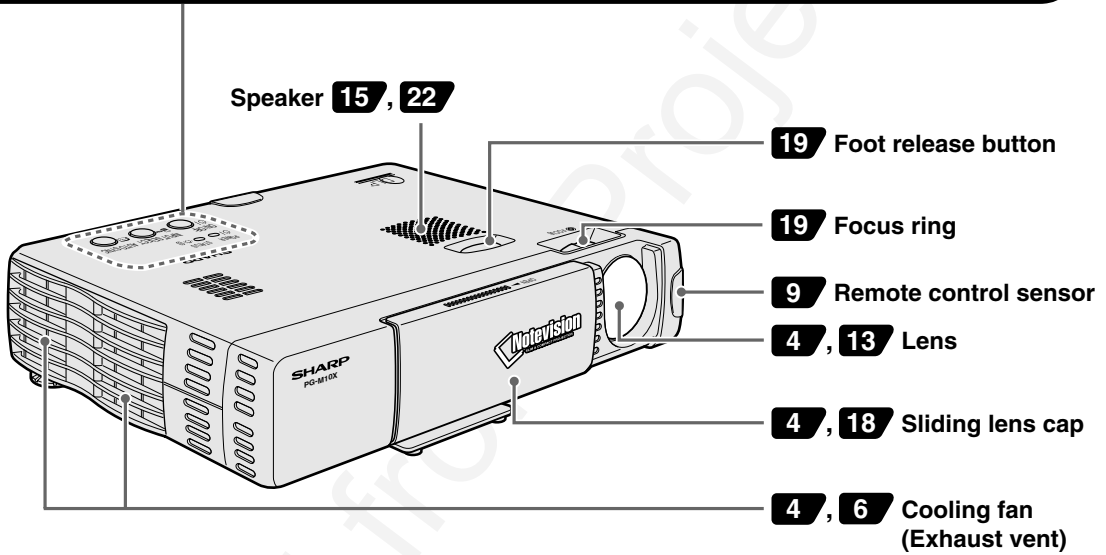
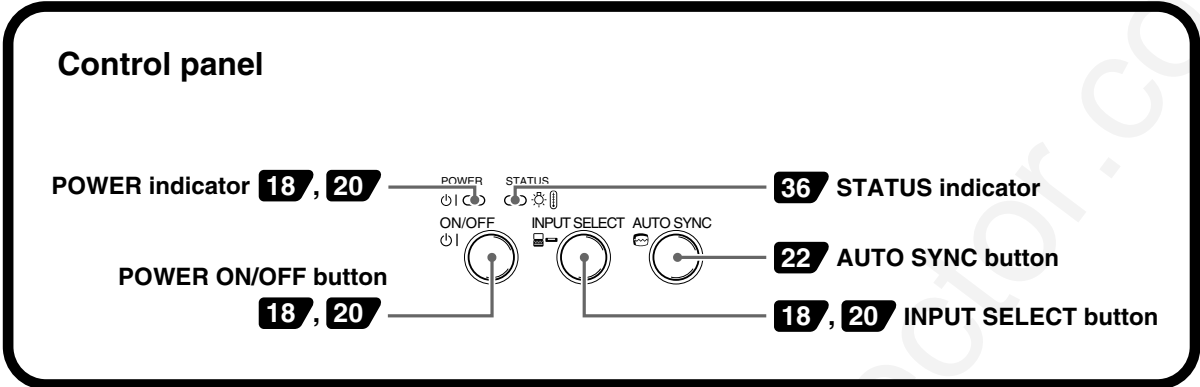

Bottom

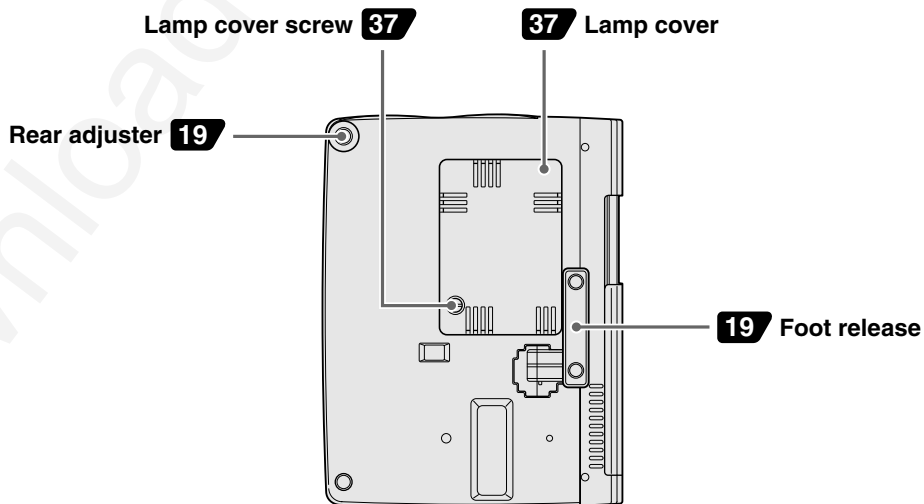



Rear and side panel view

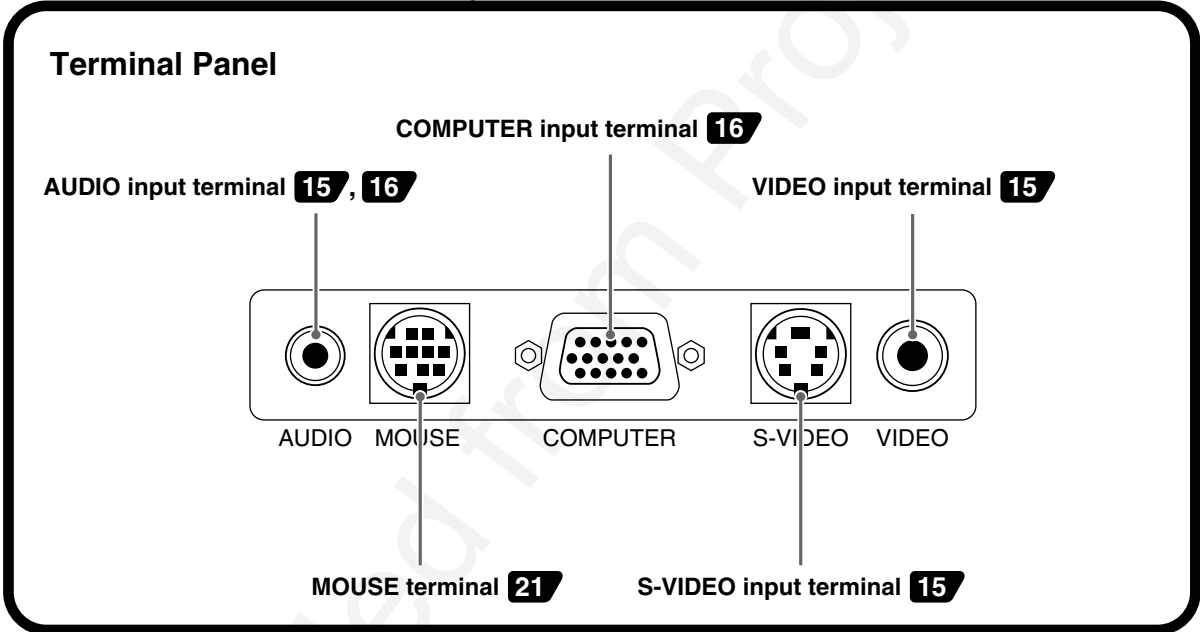
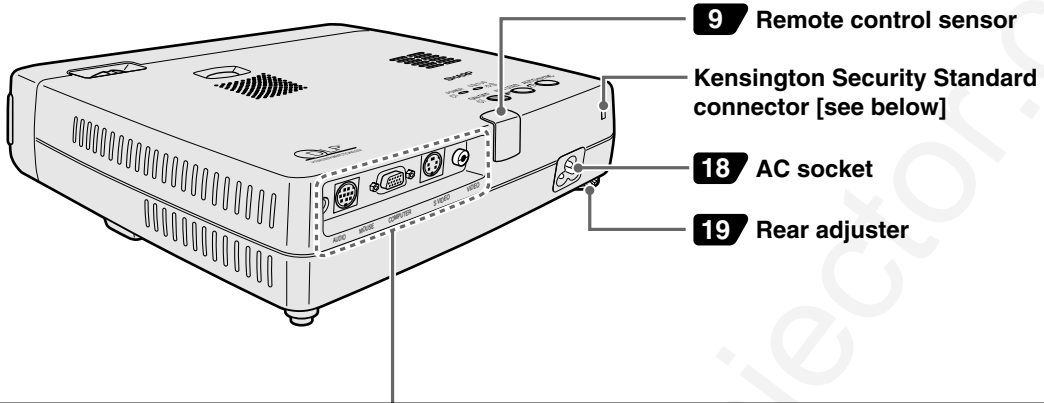

Kensington Lock



This projector has a Kensington Security Standard connector for use with a Kensington MicroSaver Security System. The logo  is trademarked and owned by Kensington Microware Inc. Refer to the information that came with the system for instructions on how to use it to secure the projector.



Remote Control

Front View

LED

The red LED lights during infrared sending.

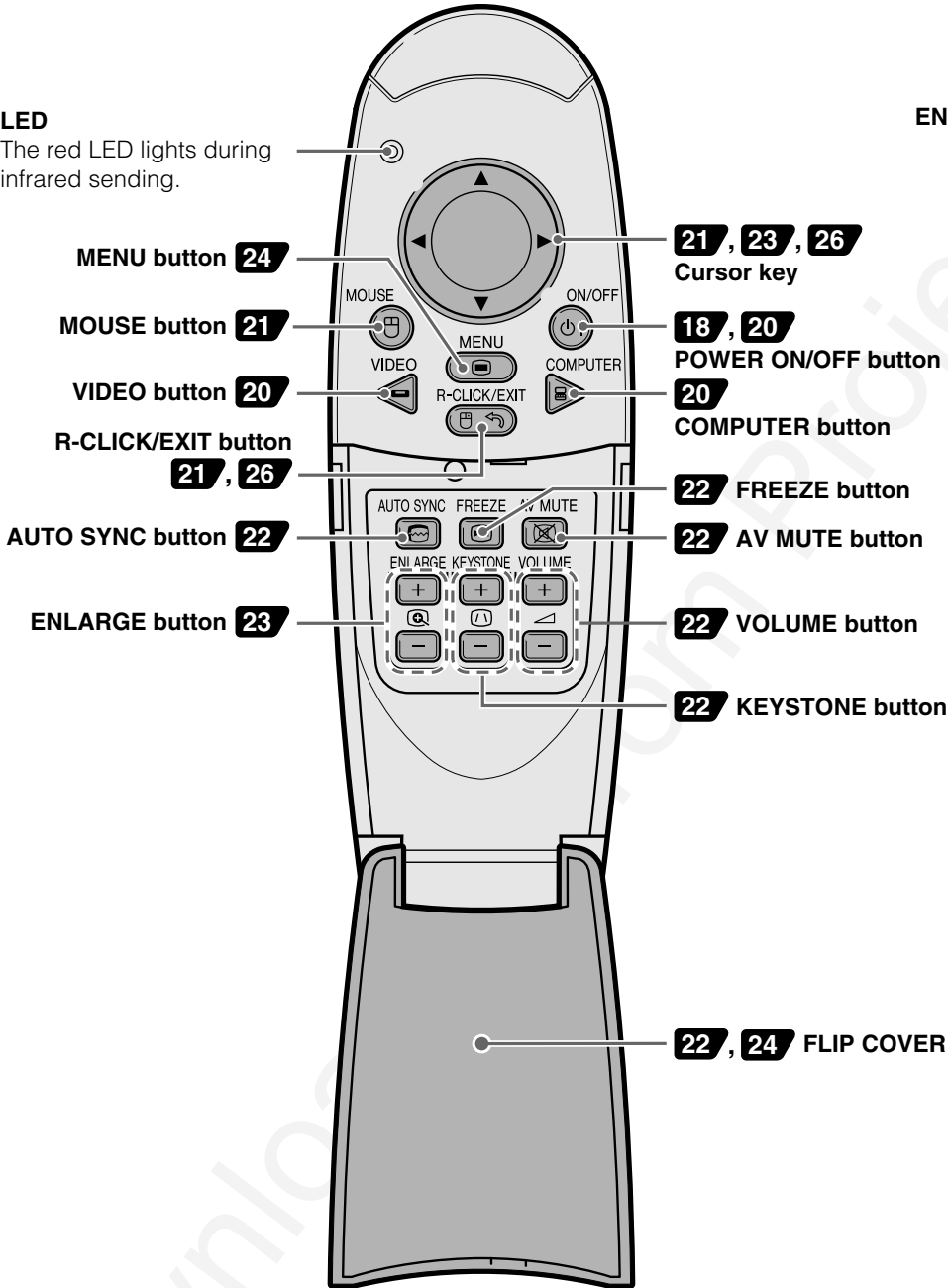

Rear View

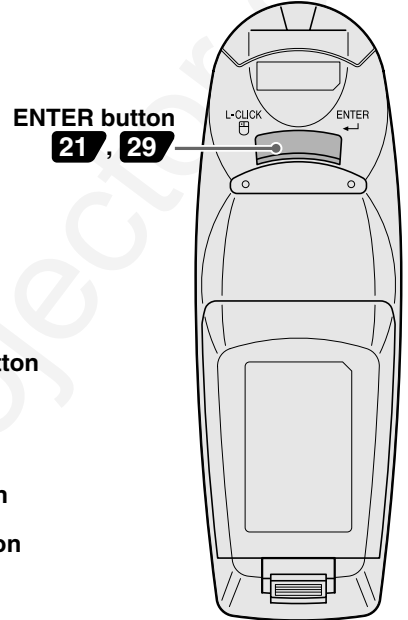

Top View

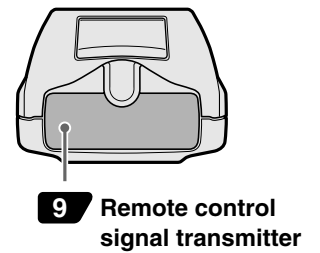

The distance from the unit lens to the screen determines the size of the projected image. Therefore, you need to consider the unit placement in relationship to the screen prior to making the electrical and signal connections. Appropriate screen size and height are directly related to the unit's position and need to be evaluated.

Tip

A non-glossy wall may be used as a substitute for a screen.

Positioning the unit

The projected image becomes larger as the distance between the unit and screen increases. The minimum image size is about 36 inches diagonally at a distance of about 1.2 m (approx. 47¹/₄ inches) and the maximum size is approx. 200 inches at a distance of 6.8 m (approx. 267¹¹/₁₆ inches) from the screen. Use the following information when you fix the position of the unit.

Projecting distance and image size

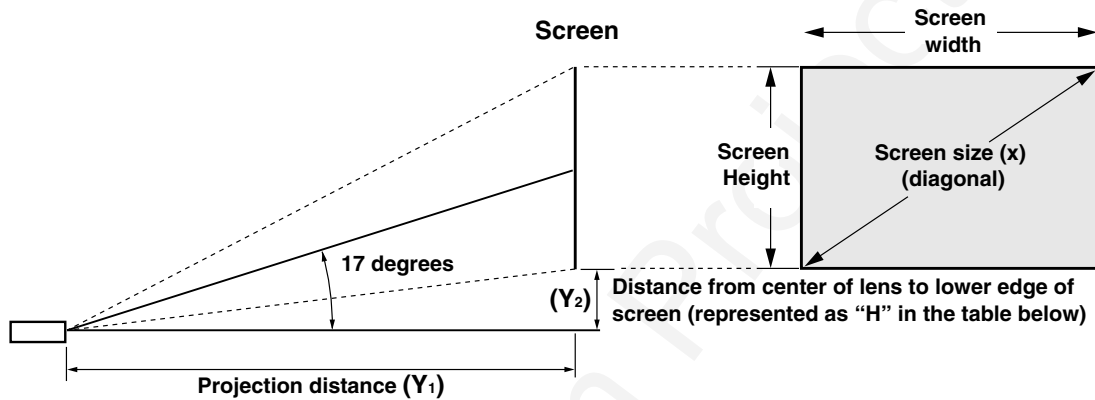

PG-M10X

Screen size	Projection distance	Dimension (H)
inches	inch / m	inch / cm
36	47 ¹ / ₄ " / 1.2	3 ¹¹ / ₁₆ " / 9.4
40	51 ³ / ₈ " / 1.3	4 ¹ / ₈ " / 10.5
60	78 ³ / ₄ " / 2.0	6 ³ / ₁₆ " / 15.7
80	106 ⁵ / ₁₆ " / 2.7	8 ¹ / ₄ " / 20.9
100	129 ¹⁵ / ₁₆ " / 3.3	10 ⁵ / ₁₆ " / 26.2
120	154 ¹ / ₂ " / 4.0	12 ³ / ₈ " / 31.4
150	196 ⁷ / ₈ " / 5.0	15 ⁷ / ₁₆ " / 39.3
180	236 ¹ / ₄ " / 6.0	18 ⁹ / ₁₆ " / 47.1
200	259 ¹³ / ₁₆ " / 6.6	20 ⁵ / ₈ " / 52.4

Throw distance (inch) $Y_1=1.304x+0.4355$
Offset (inch) $Y_2=0.103x$

PG-M10S

Screen size	Projection distance	Dimension (H)
inches	inch / m	inch / cm
36	47 ¹ / ₄ " / 1.2	3 ¹¹ / ₁₆ " / 9.4
40	55 ¹ / ₈ " / 1.4	4 ¹ / ₈ " / 10.5
60	82 ¹¹ / ₁₆ " / 2.1	6 ³ / ₁₆ " / 15.7
80	106 ⁵ / ₁₆ " / 2.7	8 ¹ / ₄ " / 20.9
100	133 ⁷ / ₈ " / 3.4	10 ⁵ / ₁₆ " / 26.2
120	161 ⁷ / ₁₆ " / 4.1	12 ³ / ₈ " / 31.4
150	200 ¹³ / ₁₆ " / 5.1	15 ⁷ / ₁₆ " / 39.3
180	244 ¹ / ₈ " / 6.2	18 ⁹ / ₁₆ " / 47.1
200	267 ¹¹ / ₁₆ " / 6.8	20 ⁵ / ₈ " / 52.4

Throw distance (inch) $Y_1=1.353x+0.4355$
Offset (inch) $Y_2=0.118x$

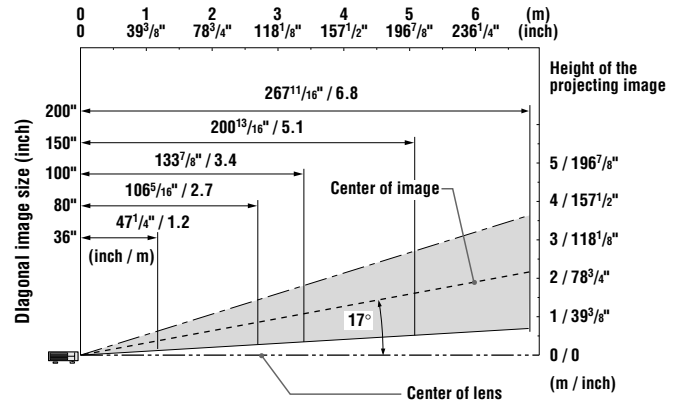
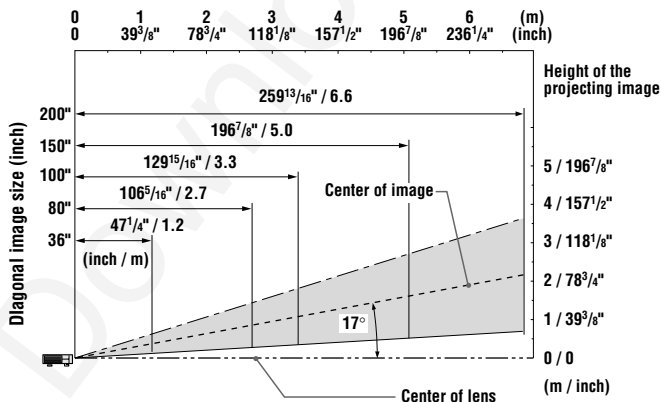



Reversed Image Setup

Rear projection

- Place a translucent screen between the unit and the audience.
- Use the unit's menu system to reverse the projected image. (See page 33)

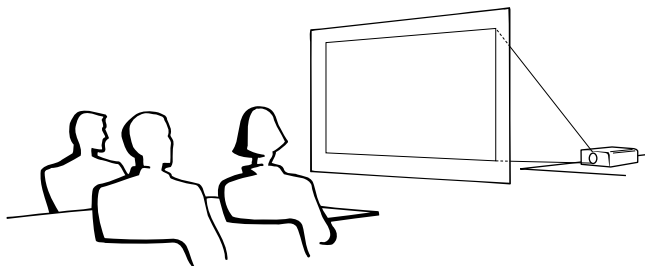

Projection using a mirror

- Place a mirror (normal flat type) in front of the lens.
- Use the unit's menu system to reverse the projected image. (See page 33)
- The image reflected from the mirror is projected onto the screen.

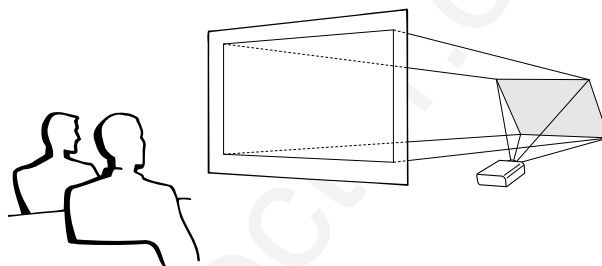

NOTE

Optimal image quality is produced with the unit positioned perpendicular to the screen with all feet flat and level.

CAUTION

When using a mirror, be sure to carefully position both the unit and the mirror so the light does not shine into the eyes of the audience.



Connecting video equipment

You can connect up to two pieces of video equipment to the unit following the illustrations below.

- You can switch the input source (picture) to VIDEO or S-VIDEO when you connect two pieces of equipment. (The S-VIDEO connection provides more vivid color and higher resolution compared to the VIDEO connection.)
- You can output the sound of only one component through the unit's speaker even when two components are connected. When connecting two external devices, the audio from either one of these devices can be output from the speaker of this unit. Audio can be turned on and off for video related input (video, S-video) from the menu or COMPUTER input terminal. (see page 31)

Connection to the VIDEO input terminal of the unit

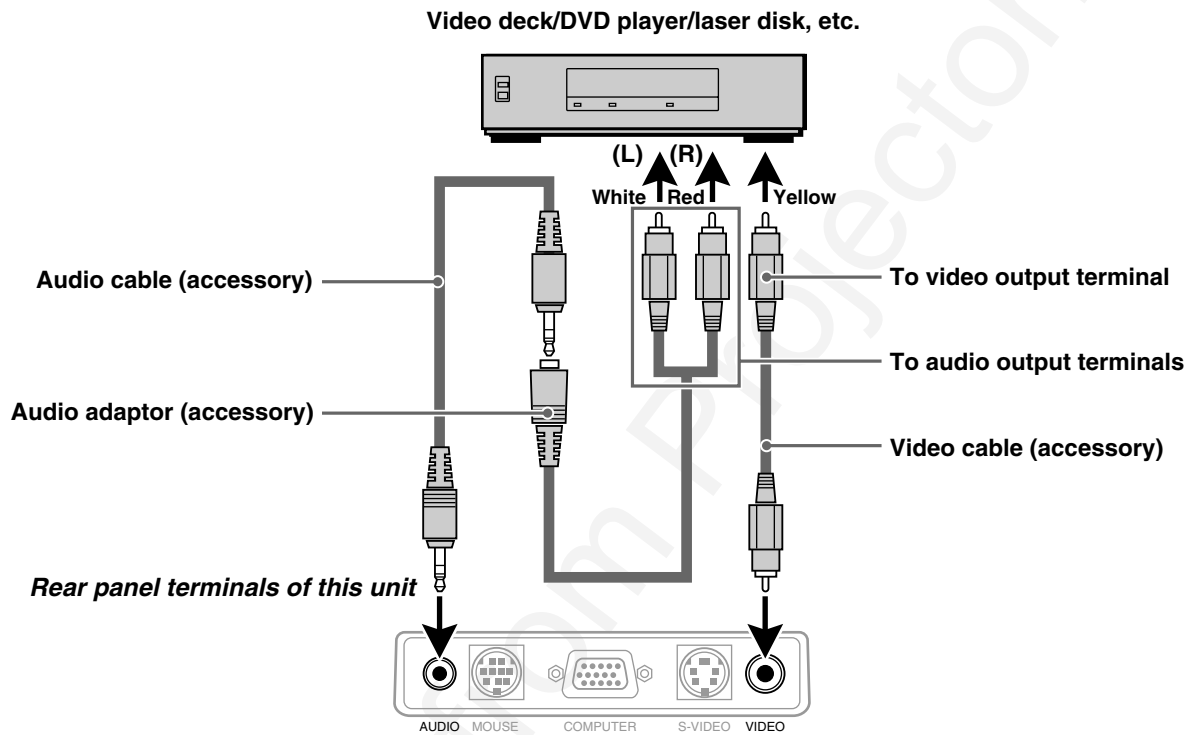

Connection to the S-VIDEO input terminal of the unit

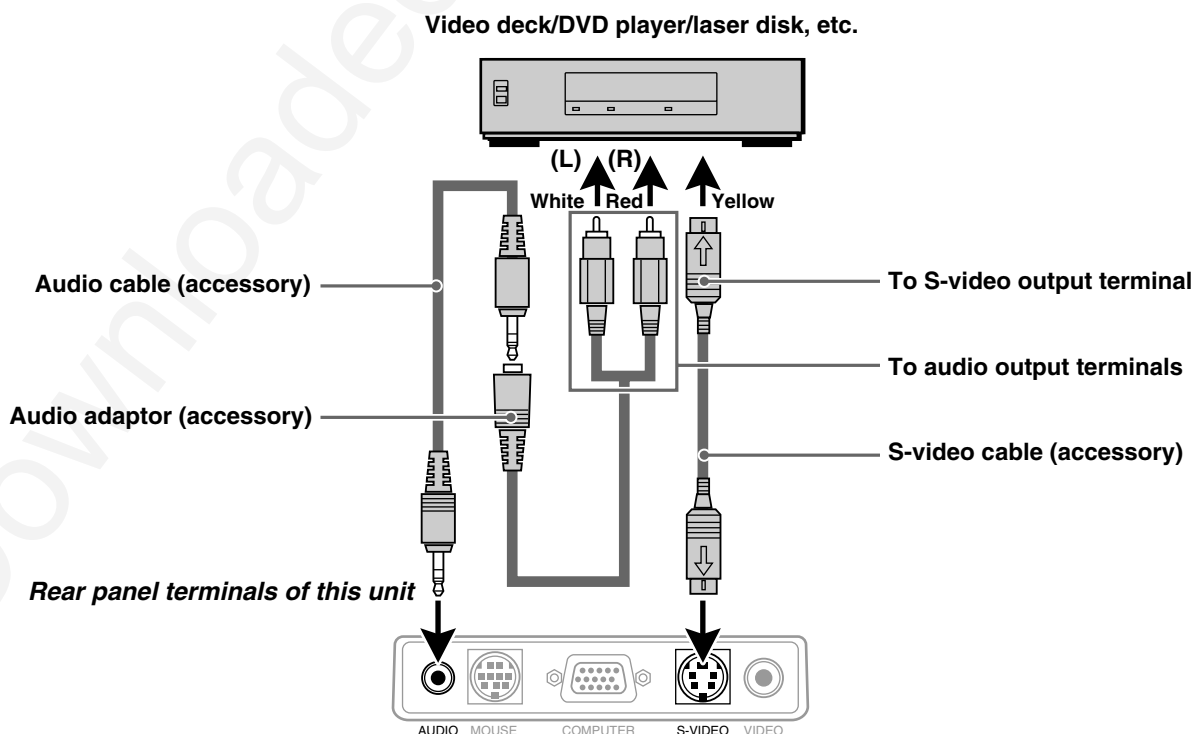



Connecting Video Equipment With Component Video Signal (YPbPr) Output

Video equipment with component video signal (YPbPr) output can be connected to this unit by setting the COMPUTER input terminal to YPbPr (see page 31) from the menu.

Note that this unit is compatible only with 480i component video.

Connection to the COMPUTER input terminal

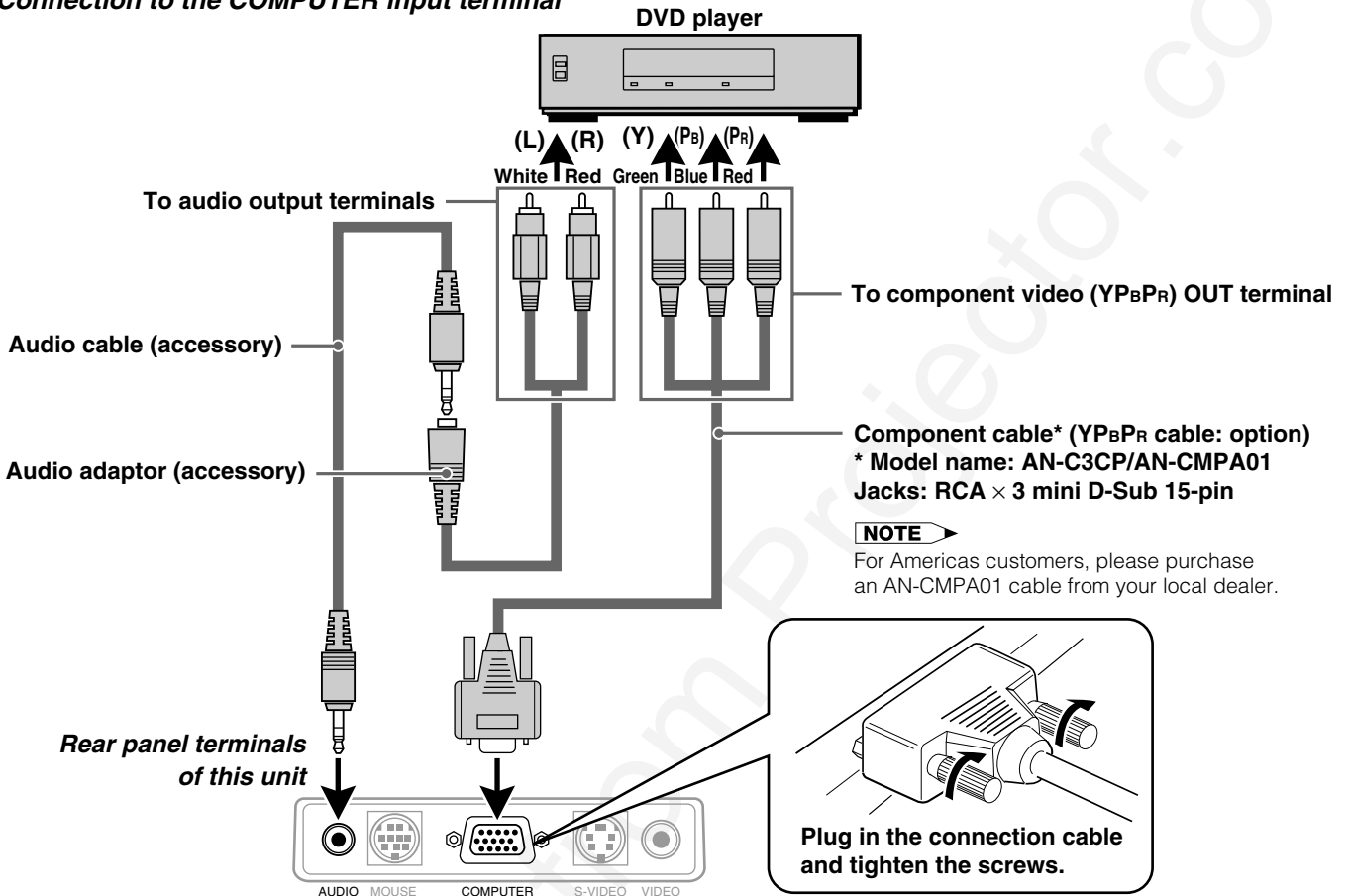

Connecting a PC or Macintosh

This unit can be used as a display for numerous applications by connecting the analog RGB output connector of a PC to the COMPUTER input terminal of this unit and setting the COMPUTER input terminal to RGB (see page 31).

- Either read the instruction manual or contact the manufacturer concerning the method used to set your PC.

IBM PC/AT compatible Macintosh mini D-Sub 15-pin monitor output connector.

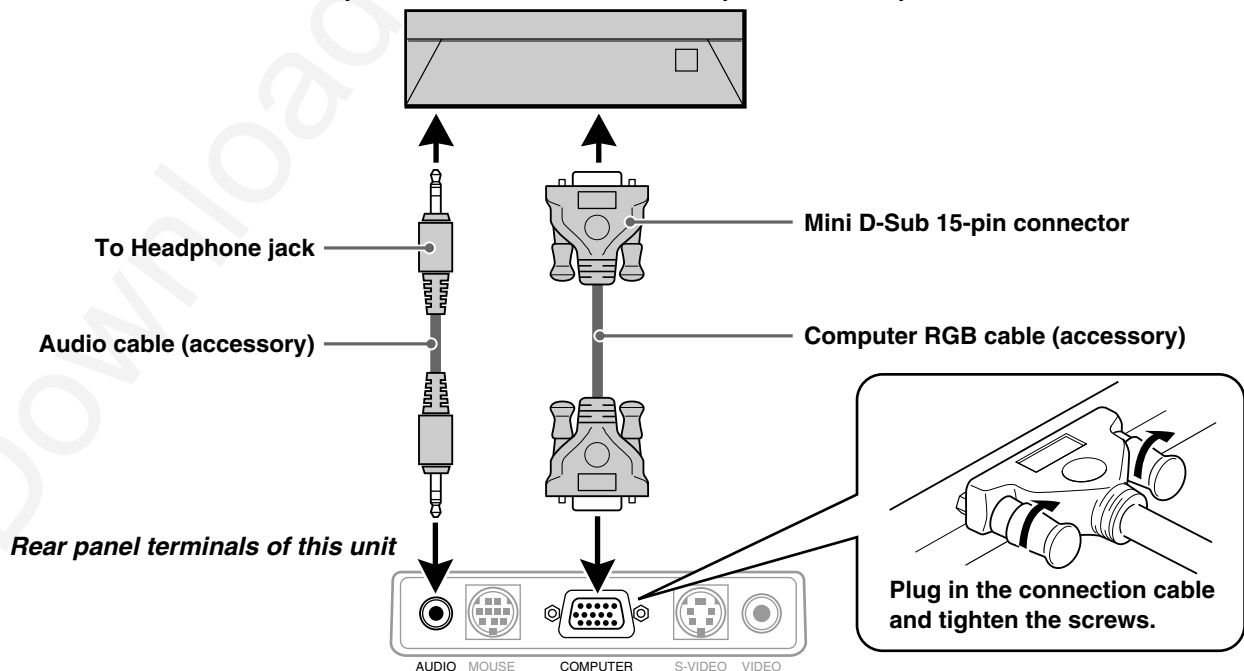



Changing the computer's video resolutions

Depending on your computer's graphics capability, you may be able to select one of several resolutions. Generally a computer- either a PC or Macintosh- with 1 MB VRAM will generally run:

640 × 480 at 16.7 million colors (24 bit true color)
800 × 600 at 65,000 colors.
1024 × 768 at 256 colors.

As the resolution increases, the number of colors you can run decreases. With 2 MB VRAM a computer will generally run:

640 × 480 at 16.7 million colors (24 bit true color).
800 × 600 at 16.7 million colors (24 bit true color).
1024 × 768 at 65,000 colors.
1280 × 1024 at 256 colors.

Windows 98/Windows 95

There are two methods you can use to change your resolution.

Method 1

- 1 Move your cursor to the background image and R-click.
- 2 In the "Properties" menu, select "Settings".
- 3 Change your resolution and click "OK".
- 4 You may be asked to reboot for the changes to take effect, or a message may appear saying that "Windows is about to resize your display". You'll be asked if you want to keep your settings. Select "Yes".

Method 2

- 1 Click on your "My Computer" icon.
- 2 Open "Control Panel" and select "Display".
- 3 Change your resolution and click "OK" after the new resolution is selected.
- 4 You may be asked to reboot for the changes to take effect, or a message may appear saying that "Windows is about to resize your display". You'll be asked if you want to keep your settings. Select "Yes".

Windows 3.1

- 1 Click on the "Main" icon and open "Control Panel".
- 2 Select "Change System Settings" and click on "Option".
- 3 Choose "Change Display Settings".
- 4 Select the resolution you want.
- 5 Choose the current or desired drive.
- 6 Restart Windows for the changes to take effect.

Macintosh

- 1 Under the Apple menu, select "Control Panels" and open "Monitors".
- 2 Click and open "Options".
- 3 Select your new resolution and click "OK".

Notebook computers and resolution standards

PG-M10X

The unit is designed to project industry standardized video such as VESA (Video Electronics Standards Association) or XGA (eXtended Graphics Array). Notebook computers do not use industry standards. They use whatever timing is necessary to match their local LCD display. The end result is typically not standard. By turning off your notebook's display, the timing parameters are a bit more like the real VESA or XGA signal.

PG-M10S

The unit is designed to project industry standardized video such as VESA (Video Electronics Standards Association) or VGA (Video Graphics Array). Notebook computers do not use industry standards. They use whatever timing is necessary to match their local LCD display. The end result is typically not standard. By turning off your notebook's display, the timing parameters are a bit more like the real VESA or VGA signal.

Receiving Video Output from Personal Computers

When a notebook type personal computer is connected for use in projecting, a certain amount of knowledge is necessary for cable connection, startup and the succeeding operations. Please refer to the instruction manual of your notebook type personal computer when performing the following operations.

1. Make sure that this unit is receiving signals from your notebook type personal computer.

The external signal may not be output even though the LCD screen of the notebook type personal computer indicates such output. Check by using the "INFORMATION" menu displayed by this unit (page 24, 25).

If 0 kHz is displayed, there is no external output signal from the personal computer.

2. If the notebook type personal computer is not outputting the external signal, perform the following operation.

For IBM PC/AT machines, press either the [Fn] key or one of the [F1] - [F12] keys.

NOTE

When displayed on the LCD display of a notebook type personal computer and this unit at the same time, the projected video may not be correct even the LCD display is normal. In such case, turn off the notebook type personal computer display and try using only the external output mode. (In some cases, external output only can be set by performing step 2 above or by closing the LCD display.)



Using the unit

Before Using, open the sliding lens cap.

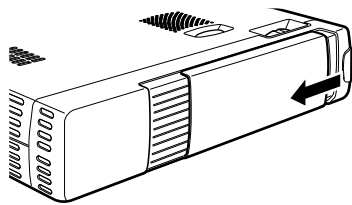

1 Connect the power cord.

The POWER indicator will illuminate orange in color indicating that the unit is in standby status. The cooling fan will operate at slow speed.

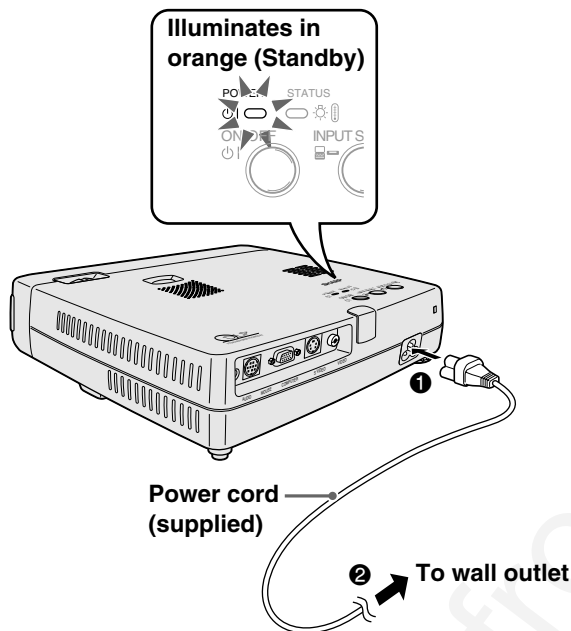

NOTE

The configuration of wall outlets differs from country to country. Use the power cord that corresponds to the wall outlet in your country.

2 Press the POWER ON/OFF button on the remote control, or the POWER ON/OFF button on top of the unit, to turn on the unit.

The POWER indicator on top of the unit turns to green and starts flashing. It takes one minute for the unit to be ready for use. Wait until the indicator stops flashing and illuminates steadily in green. This will prevent the unit from accidental shutoff.



Green light flashes (About one minute)

Then illuminates steadily in green

NOTE

- While the POWER indicator is flashing, the unit doesn't turn off even if you press the POWER ON/OFF button on the remote control, or the POWER ON/OFF button on the unit.

3 Turn on the connected source (computer, VCR, DVD player, etc.).

If you use a video component, start playback for screen/image adjustment.

4 Select the input by pressing either the VIDEO or COMPUTER button of the remote control, or the INPUT SELECT button of the unit (refer to page 20).

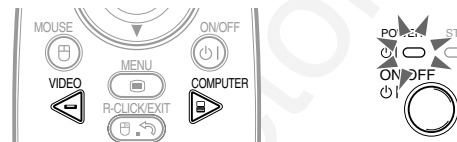

NOTE

- If no signal is being sent to the unit, the blue or black screen (the background type differs depending on the "BACKGROUND" setting. See page 32.) is projected. Check the following:
 - Is the source properly connected to the unit?
 - Is the source component or computer turned on?
- The video resolution of the connected computer can be changed. See page 17.

5 Adjust the position and height of the unit.

Move the unit to the position where the projected image is horizontally centered to the screen.

• When the projected image is offset horizontally

Adjust the position of the unit so that the unit is square to the screen.

View from the top

Screen

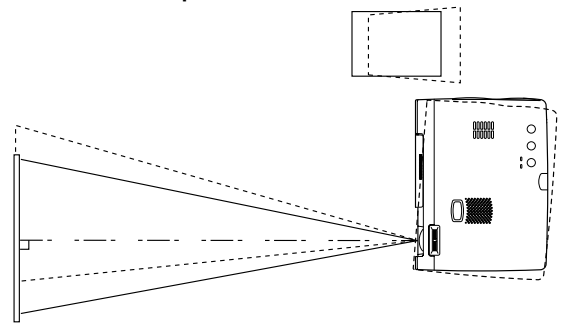

• When the projected image is offset vertically

Adjust the height balance of the unit with the adjusters. See next page.

Side view

Screen

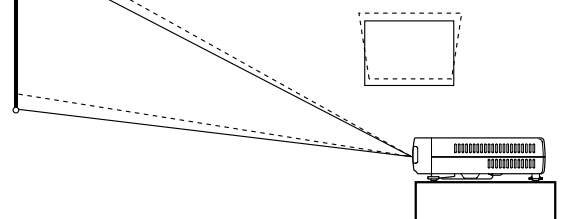



Adjuster Adjustment

There are two adjusters: one on the right side of the back panel and another in the front center of the unit.

- ① Use right hand to lift the front of the unit to approximately the desired adjustment angle.
- ② Press the foot release button on the front. Loosen the foot release and allow it to drop into position.
- ③ Release the button. The extended foot release will be locked.
- ④ Rotate the contact surfaces of the rear adjuster either clockwise or counterclockwise to accurately adjust the level.

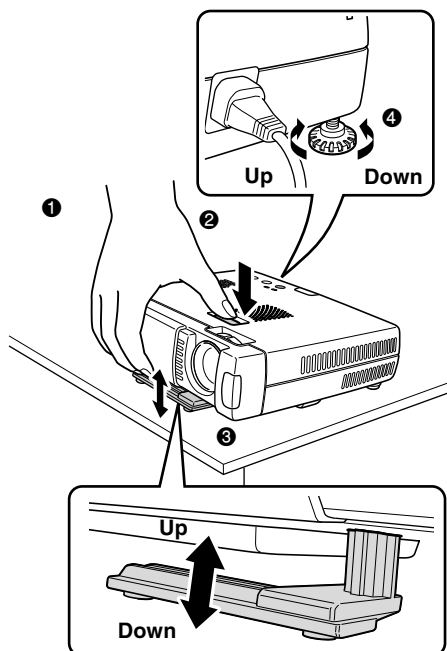

- 6** When distortion of the projected image cannot be corrected with the adjusters, press the **KEYSTONE +/-** buttons of the remote control to fine adjust (see page 22).

Using KEYSTONE to adjust projected image distortion.

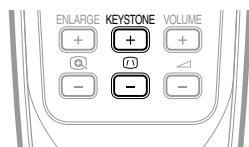
**NOTE**

Maximum correction is 14 degrees (including optical correction).

The top and bottom of the projected image is corrected, as shown below.

If a menu is being displayed, distortion of the menu will not be corrected.

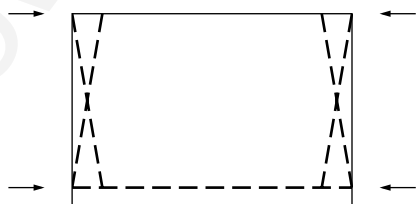

- 7** Adjust the image size to match the distance to the screen. Next, use the focus ring to adjust the focus.

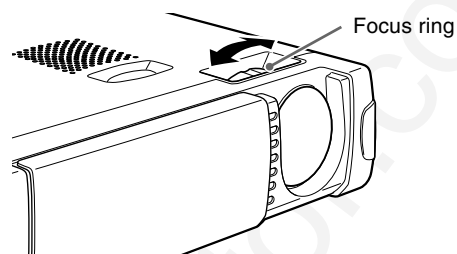

- 8** Change the unit setting to suit the method and source selected in step 4.

- **Select the "PROJECTION" appropriate for the type of projector installation. (See page 33)**

If the image is projected reversed, vertically, or horizontally, reset "PROJECTION".

- **In the case of video or S-video, select the color system as necessary. (See page 30)**

Normally, it is not necessary to change the factory settings. Also, set the COMPUTER input terminal for YPbPr (component video). (See page 31)

- **In the case of RGB input, adjust the video of the connected PC.**

This unit automatically identifies the input signal and selects the most appropriate resolution.

However, manually adjust the "CLOCK" and "PHASE" (see page 28) when there is flicker, noise, color offset, etc., and manually adjust the vertical and horizontal position (see page 28) when the image is not centered.

You can maintain the original aspect ratio of the incoming signal. (see page 31). (Normally, the resolution is automatically detected and the display is enlarged or reduced.)

- 9** Adjust the picture elements (see page 26), then select the picture type according to the video content (see page 30).

- 10** Start using the unit.

The following functions are available while using the unit:

- **Adjusting the volume of the unit's speaker (see pages 22 and 32),**
- **Turning off the image and muting the sound temporarily (see page 22),**
- **Freezing a moving picture (see page 22),**
- **Enlarging the picture (see page 23)**

NOTE

When there is no signal input for a period of 5 min. or more, the power is automatically turned off and standby status is activated.





Using the Remote Control (Input Selection)

Using the unit (continued)

After using the unit

1 Press the POWER ON/OFF button of the remote control or the POWER ON/OFF button of the main unit for a few seconds.

The power will turn off and the POWER indicator will blink orange for 1 min., then the standby status will be activated. (The cooling fan will continue to run for a while for cooling purposes.)

Do not unplug the power cord while the indicator is blinking.

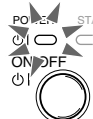
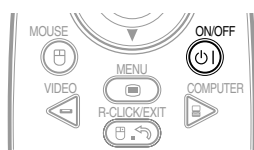

Blinks orange (1 min.)

↓
Illuminates orange

NOTE

- The POWER ON/OFF button of the remote control and main unit will not operate until the blinking stops.
- After the standby status is activated, wait 1 min. or more before turning the power on again. The power will not turn on until the 1 min. interval has elapsed.
- The cooling fan will continue to run even in standby status.

2 Disconnect the power cord.
The POWER indicator will turn off.

Using the Remote Control (Input Selection)

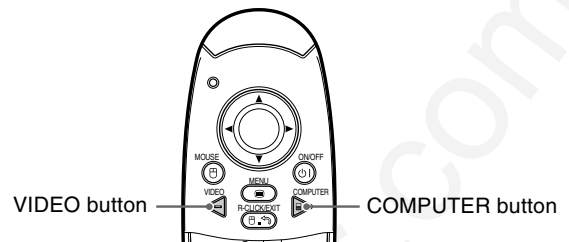

Operating from the main unit

Inputs can be selected not only by operating the remote control but also by using the projector's INPUT SELECT button.

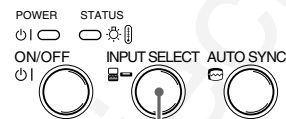

INPUT SELECT button

1 Press the VIDEO button.

The video signal (VIDEO, S-VIDEO) connected to the input terminal of this unit will be detected and projected automatically. If a video signal is not detected, the message NO SIGNAL will be displayed.



2 Press the COMPUTER button.

The analog RGB signal connected to the input terminal of this unit will be detected and projected automatically. (Component video will be detected if the COMPUTER input terminal is set to "YPbPr" (page 31).) If a video signal is not detected, the message NO SIGNAL will be displayed.



NOTE

All video signals input to this device will be detected if "AUTO SOURCE" is set to "ON" (page 33).

3 Press the INPUT SELECT button.

The video signal (RGB or YPbPr, VIDEO, S-VIDEO) connected to the input terminal of this unit will automatically be detected and projected. If a video signal is not detected, the message NO SIGNAL will be displayed.



The signals are detected repeatedly in the sequence shown below.

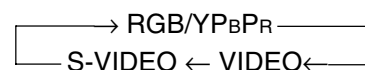

NOTE

When "AUTO SOURCE" is set to "ON" (see page 33), all signals input to this unit will be detected.



Using the Remote Control as the PC Mouse

The remote control of this unit can be used as the PC mouse (wireless mouse function) by connecting the MOUSE terminal of this unit and the PC.

Remote control mouse functions

- The cursor key on the remote control operates the computer mouse functions.
- If a computer running Windows is connected, the ENTER button on the remote control operates as the computer mouse left click button and the R-CLICK/EXIT button as the computer mouse right click button.
- If a Macintosh computer is connected, the ENTER and R-CLICK/EXIT buttons operate in the same way as the computer mouse click button.

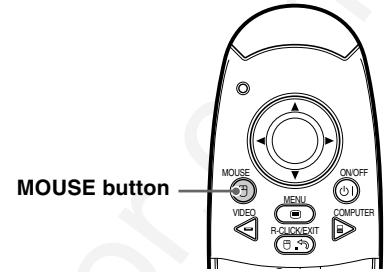

Connecting a PC and the MOUSE terminal of this unit

Before connecting a PC

- Before connecting, turn off the PC power. Turn off the power of this unit if it is on.
- When connection is completed, turn on the power of this unit and then start the PC.

USB Port Connection

Connect the supplied USB mouse control cable directly to the USB port (universal serial bus) of the personal computer, as shown in the diagram.

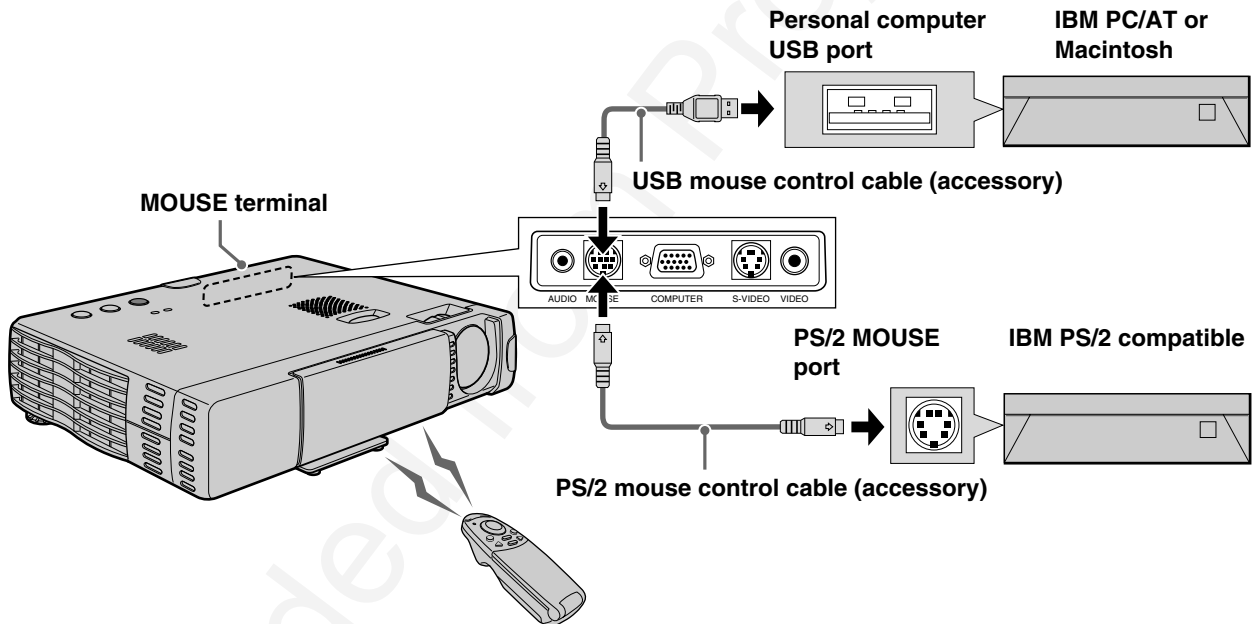

IBM PS/2 Mouse Port Connection

Connect the supplied PS/2 mouse control cable to the personal computer, as shown in the diagram.

NOTE

- Depending on the personal computer, the mouse may not be recognized in some cases if not connected to the MOUSE terminal before the personal computer power is turned on.
- In the case of some notebook and laptop type personal computers, it may not be possible to use the standard pointing device (track ball, etc.) of the personal computer when connected to the MOUSE terminal. In such case, it will not be possible to use the pointing device until the personal computer is rebooted, even if disconnected from the MOUSE terminal.
- Windows 95 does not support USB mouse driver software.





Various functions while using the unit

The following operations can be performed by opening the FLIP COVER of the remote control.

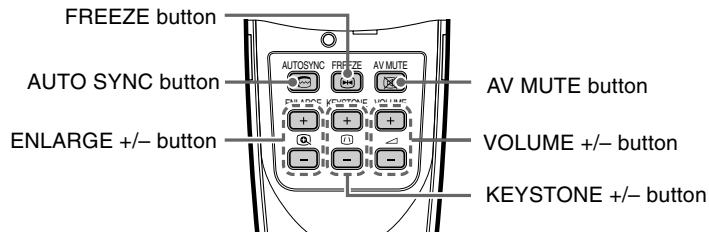

Automatic Screen Adjustment

Press the **AUTO SYNC** button.



The position and size of the input image will be adjusted automatically in accordance with the resolution.

NOTE

- Operation is the same as with the AUTO SYNC button of the main unit.
- When the optimum image cannot be achieved with Auto Sync adjustment, use manual adjustments.

Freezing animated images

You can capture the desired frame of a moving picture.

Press the **FREEZE** button.

A still image of the current frame is displayed. To restore the present picture, press the button again.



Tip

The still picture can also be enlarged (see page 23).

Turning off the image and muting the sound temporarily

Press the **AV MUTE** button.

The image turns off and the sound is muted at the same time. To restore the picture and sound, press the button again.



Adjusting the Volume

Adjusting the volume of the unit's speaker.

Press the **VOLUME +** button to increase the volume or **-** to decrease.



KEYSTONE Adjustment

When distortion of the projected image cannot be compensated with the adjusters, press the **KEYSTONE +/-** button to adjust accurately.

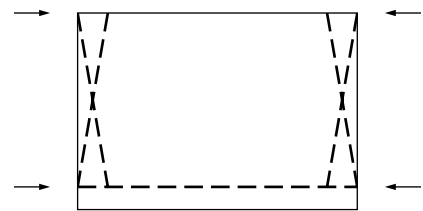
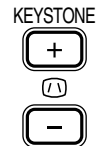

Using the KEYSTONE button to adjust the top and bottom of a projected image.

The top and bottom of the projected will be compensated, as shown in the diagram. If the menu is displayed, distortion of the menu itself will not be compensated.

NOTE

When keystone adjustment is used, you may select to enlarge the image to compensate for the adjustment or leave the image size unaltered. (see page 32).

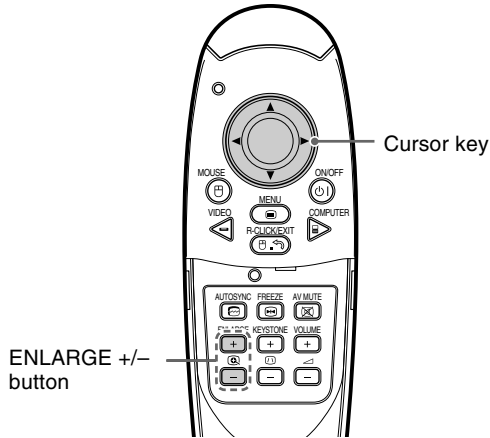

To move to the desired portion of the enlarged picture

Press the desired portion of the cursor key.

The available directions are indicated by the four large triangle marks on the cursor key. The picture will move in the direction of the mark you are pressing.

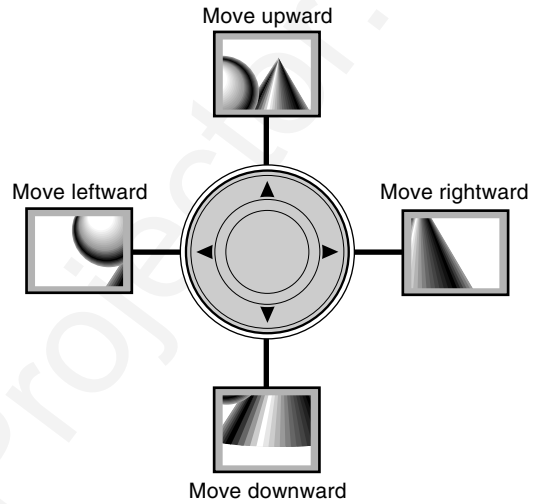

NOTE

Pictures that have been reduced cannot be moved using this function.



Enlarging the picture

Press the ENLARGE + button.

While the button is pressed, the picture is enlarged. Release the button at the desired size.

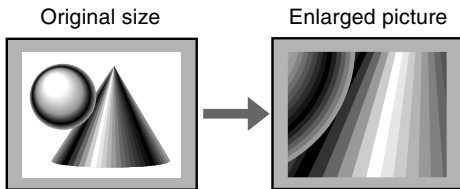
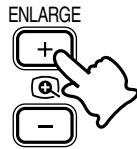

NOTE

The quality of the enlarged picture deteriorates compared to the original size picture.

Screen Reduction

Press the ENLARGE - button.

When this button is released, the picture will return to 90% reduction.

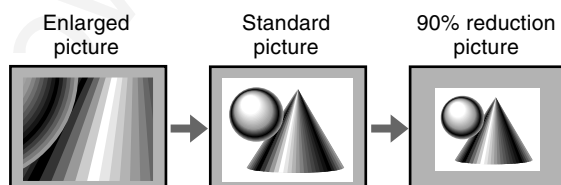

Menu operation

Menu Structure

The **normal menu** will be displayed when the MENU button is pressed with the remote control FLIP COVER closed.

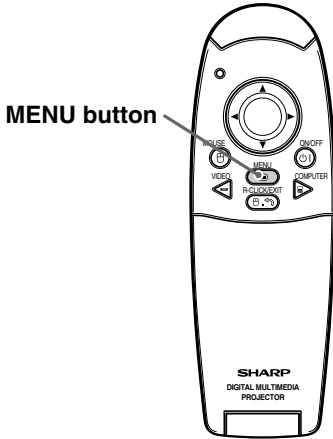

The numerals noted in  are reference page numbers.

Normal menu

For VIDEO, S-VIDEO and component video (YPbPr) input





IMAGE	INFORMATION	
BRIGHTNESS	- 0 -	 26
CONTRAST	- 0 -	 26
COLOR	- 0 -	 26
TINT	- 0 -	 26
SHARPNESS	- 1 -	 26

IMAGE	INFORMATION	
RESET		29
LAMP USAGE HOURS RESET		29
LAMP USAGE	- 34-	
STATUS	-0.03 12 -	

The **advanced menu** will be displayed when the MENU button is pressed with the remote control FLIP COVER open.

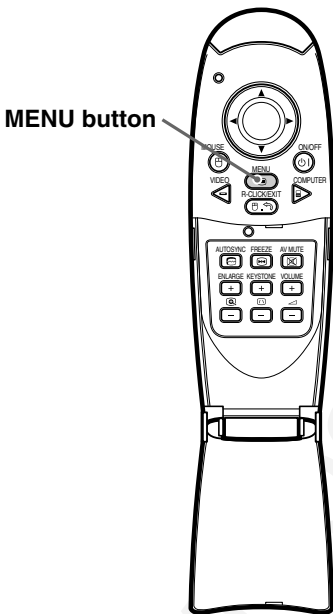

Advanced menu

For VIDEO, S-VIDEO and component video (YPbPr) input

IMAGE	COLOR	VIEW	SETUP	OPTION	INFO.	
GAMMA	NORMAL	NATURAL	REAL	CUSTOM		30 →
COLOR TEMP.	LOW	MIDDLE	NORMAL	HIGH		30 →
VIDEO TYPE		DVD		VCR		30 →
		COLOR SYSTEM				30 →
SOURCE CHANGE		RGB		YPbPr		31 →

IMAGE	COLOR	VIEW	SETUP	OPTION	INFO.	
ASPECT		REAL	AUTO	DIRECT	4:3▶16:9	31 →
FILTER		-1-				31 →
KEystone		NORMAL		FULL		32 →

Common menu

IMAGE	COLOR	VIEW	SETUP	OPTION	INFO.	
SOUND MUTE		OFF		ON		32 →
BACKGROUND		BLUE		BLACK		32 →
AUTO GAIN		OFF		ON		32 →
AUTO SOURCE		OFF		ON		33 →
		PROJECTION				33 →
AUTO POWER OFF		OFF		ON		33 →

Common menu

IMAGE	COLOR	VIEW	SETUP	OPTION	INFO.	
		LANGUAGE				34 →
		MENU POSITION				34 →
MENU TYPE		TRANSLUCENT		OPAQUE		34 →
DISPLAY TIME			-12 Sec-			34 →
ON SCREEN		OFF		ON		34 →



Normal menu

RGB input

IMAGE	INFORMATION	
BRIGHTNESS	- 0 -	<input type="range"/> 26
CONTRAST	- 0 -	<input type="range"/> 26
CLOCK	- 0 -	<input type="range"/> 28
PHASE	- 0 -	<input type="range"/> 28
	POSITION	<input type="range"/> 28

IMAGE	INFORMATION	
	RESET	29
	LAMP USAGE HOURS RESET	29
RESOLUTION	-1024- X -768-	
FREQUENCY	-H: 48.4 KHz- -V: 60 Hz-	
LAMP USAGE	- 34- STATUS -0.02 12 -	

Advanced menu

• The Advanced menu cannot be used unless the FLIP COVER of the supplied remote control is open.

RGB input

IMAGE	COLOR	VIEW	SETUP	OPTION	INFO.	
GAMMA	NORMAL	NATURAL	REAL	CUSTOM		30
COLOR TEMP.	LOW	MIDDLE	NORMAL	HIGH		30
SOURCE CHANGE	RGB		YPbPr			31

IMAGE	COLOR	VIEW	SETUP	OPTION	INFO.	
ASPECT	REAL	AUTO	DIRECT	4:3	16:9	31
FILTER	-1-	<input type="range"/>				31
KEystone	NORMAL		FULL			32
	PAN					32

INDEX	- 0 -	<input type="range"/>	30
RED	- 0 -	<input type="range"/>	
GREEN	- 0 -	<input type="range"/>	
BLUE	- 0 -	<input type="range"/>	

RED	- 0 -	<input type="range"/>	30
GREEN	- 0 -	<input type="range"/>	
BLUE	- 0 -	<input type="range"/>	

AUTO	30
NTSC	
NTSC 4.43	
PAL	
PAL M	
PAL N	
PAL60	
SECAM	

NORMAL	33
VERTICALLY+HORIZONTALLY	
REVERSED HORIZONTALLY	
REVERSED VERTICALLY	

ENGLISH	34
Deutsch	
Français	
ITALIANO	
Español	
Svenska	
中文	
日本語	



Adjusting the picture elements

The picture elements such as brightness, contrast, white balance, and so on can be adjusted individually for each input source. The adjustable items vary depending on the input source.

(The elements marked with “●” are adjustable.)

Input source	VIDEO/S-VIDEO	COMPONENT VIDEO	RGB
BRIGHTNESS	●	●	●
CONTRAST	●	●	●
COLOR	●	●	–
TINT	●	●	–
SHARPNESS	●	●	–

For VIDEO, S-VIDEO and component video (YPbPr) input.

- | | | | |
|----------|--|-----------|--|
| 1 | Select the input source (see page 20) | 7 | Press the cursor ▼ / ▲ keys to select “COLOR”. |
| 2 | Press the MENU button to display the menu, hold down the cursor ◀ / ▶ keys or the MENU button and then select “IMAGE”. | 8 | Press the cursor ◀ / ▶ keys to adjust the color. |
| 3 | Press the cursor ▼ / ▲ keys to select “BRIGHTNESS”.
The items that appear in the menu will differ depending on the input. | 9 | Press the cursor ▼ / ▲ keys to select “TINT”.
NOTE ▶
This adjustment is not possible with the SECAM color system. |
| 4 | Press the cursor ◀ / ▶ keys to adjust the brightness. | 10 | Press the cursor ◀ / ▶ keys to adjust the tint. |
| 5 | Press the cursor ▼ / ▲ keys to select “CONTRAST”. | 11 | Press the cursor ▼ / ▲ keys to select “SHARPNESS”. |
| 6 | Press the cursor ◀ / ▶ keys to adjust the contrast. | 12 | Press the cursor ◀ / ▶ keys to adjust the sharpness. |

To close the menu
Press the R-CLICK/EXIT button.



Adjusting the projected image from the computer

The unit selects the most suitable resolutions as shown in the "Timing Chart" below according to the incoming signals from the COMPUTER input terminal. However, you may need manual adjustment depending on the computer. If you have any vertical banding, noise, dot interference, or crosstalk on the projected picture, adjust the clock frequency with "CLOCK" then the clock phase with "PHASE" (see page 28). You can also adjust the horizontal and vertical position of the image (see page 28).

When adjusting manually, you can choose to project the image at the original size of the incoming signal resolution (see page 31). (Normally, the image is enlarged or reduced to the most suitable size automatically.)

Timing Chart

	Resolution	H Sync. (kHz)	V Sync. (Hz)
IBM PC/AT compatible machine	640 × 350	31.5	70.1
	640 × 350	37.9	85.1
	720 × 350	31.5	70.0
	640 × 400	31.5	70.1
	640 × 400	37.9	85.1
	720 × 400	31.5	70.0
	720 × 400	37.9	85.0
	640 × 480	31.5	60.0
	640 × 480	37.9	72.8
	640 × 480	37.5	75.0
	640 × 480	43.3	85.0
	800 × 600	35.2	56.3
	800 × 600	37.9	60.3
	800 × 600	46.9	75.0
	800 × 600	48.1	72.2
	800 × 600	53.7	85.1
	1024 × 768	48.4	60.0
	1024 × 768	56.5	70.1
	1024 × 768	58.1	72.0
	1024 × 768	60.0	75.0
1024 × 768	68.7	85.0	
1280 × 1024	64.0	60.0	
1280 × 1024	80.0	75.0	
1280 × 1024	91.1	85.0	
Apple Macintosh	640 × 480	35.0	66.7
	*832 × 624	49.7	74.5
	1024 × 768	60.2	74.9
	1152 × 870	68.7	75.6
	1280 × 1024	81.1	76.1
Sun	1152 × 900	61.8	66.0
	1280 × 1024	74.9	69.9
	1280 × 1024	81.1	76.1
SGI	1024 × 768	49.7	60.4
	1280 × 1024	63.9	60.0
	1152 × 900	71.7	76.1
HP	1280 × 1024	78.1	72.0

PG-M10X

The resolution of the unit is 1024 × 768. Other resolution images (e.g. 1280 × 1024) are compressed into 1024 × 768. In such a case, projected letters and lines might appear unevenly.

PG-M10S

The resolution of the unit is 800 × 600. Other resolution images (e.g. 1024 × 768) are compressed into 800 × 600. In such a case, projected letters and lines might appear unevenly.

NOTE

* Due to native pixel resolution of the panels (800 × 600), this unit will not display Mac 832 × 624 resolution images full screen.





Manual Adjustment of Personal Computer Images

Adjusting Clock Frequency and Phase

- 1** Select RGB as the input (page 20).
- 2** Press the MENU button to display the main menu and then press the cursor ◀ / ▶ keys to select the "IMAGE".
- 3** Press the cursor ▼ / ▲ keys to select the "CLOCK".
- 4** Press the cursor ◀ / ▶ keys and adjust the image width in relation to the screen.
Adjustment is performed in dot units. Adjust to the position where vertical flicker disappears.
- 5** Press the cursor ▼ / ▲ keys and select "PHASE".
- 6** Press the cursor ◀ / ▶ keys and adjust to minimize image noise, flicker, color variations, etc.

Reconnecting a separate personal computer or other device to the COMPUTER input terminal

Either press the AUTO SYNC button on the main unit or open the FLIP COVER of the remote control and press the AUTO SYNC button there.

If no images appear during setting

Use the following procedure when no images appear during setting because the clock frequency or phase is grossly inaccurate.

- 1 Turn off the power of all devices connected.
The input signal will stop and either a blue or black background (This depends on the "BACKGROUND" setting on page 32) will be projected.
- 2 Perform a reset (page 29).
- 3 Readjust the "CLOCK" and "PHASE"

Adjusting the position of the image

If the image is offset up, down, left or right, adjust the vertical and horizontal position.

- 1** Perform steps 1 - 6 for "Adjusting the Clock Frequency and Phase" on this page.
- 2** Press the cursor ▼ / ▲ keys and select "POSITION".
- 3** Press the cursor ▼ / ▲, ◀ / ▶ keys and adjust the horizontal and vertical position.



To close the menu
Press the R-CLICK/EXIT button.

Resetting

Resetting the factory defaults

All items can be reset to the standard settings with the exception of the followings.

- Lamp usage timer
- “KEystone” adjustment values (including the “KEystone” setting value on page 32).

- 1** Press the remote control MENU button to display the normal menu and then press the cursor ◀ / ▶ keys to select “INFORMATION”.
- 2** When the “INFORMATION” menu appears, press the cursor ▼ / ▲ keys select “RESET”, then press the ENTER button.
- 3** If the ENTER button is not used during reset, press the R-CLICK/EXIT button.

Resetting the Lamp Usage Timer

When the lamp is replaced (page 37), it is necessary to set the lamp hours of usage from the menu.

- 1** Press the remote control MENU button, use the cursor ◀ / ▶ keys to display the “INFORMATION” menu and set the lamp hours of usage.
- 2** Display the “INFORMATION” menu, use the cursor ▼ / ▲ keys to select “LAMP USAGE HOURS RESET” and then press the ENTER button.
- 3** If the ENTER button is not used during reset, press the R-CLICK/EXIT button.

When the lamp usage timer has exceeded 1100 hours and the unit will not turn on

The power will not turn on when the lamp hours of usage has exceeded 1100 hours. The STATUS indicator will be on continually (page 36). Thus, the menu cannot be displayed. In such case, replace the lamp housing, then use the following procedure to reset.

- 1** Connect the power cord (page 18).
Standby status will be activated.
- 2** Press the INPUT SELECT and AUTO SYNC buttons of the main unit at the same time for 5 sec. or more.
The lamp usage timer will be reset. After resetting, the STATUS indicator (page 36) that turned on because 1100 hours had been exceeded will turn off.

NOTE

The lamp hours of usage will be displayed on the screen when it has exceeded 1000 hours.

To close the menu
Press the R-CLICK/EXIT button.



Advanced Menu Settings

Set the colors as desired in accordance with the image contents.

Subtle color settings are possible, as desired. Setting is possible for each input.

- 1 Select the image to be input (page 20).
- 2 With the FLIP COVER of the remote control open, press the MENU button to display the Advanced menu, then use the cursor ◀ / ▶ keys to select "COLOR".
- 3 Use the cursor ▼ / ▲ keys to select "GAMMA".
- 4 Use the cursor ◀ / ▶ keys to set the "GAMMA".
The following can be selected.
● Normal ● Natural ● Real ● Custom
Normal is standard settings; Natural stresses coloring; Real stresses brightness. Custom is used to adjust freely as desired.
- 5 Use the cursor ◀ / ▶ keys to select "CUSTOM", press the ENTER button to display the sub-menu and then set the gamma value. There are 33 index values.

Adjusting Color Balance

Color balance (white balance) can be set for each input.

- 1 Select the image to be input (page 20).
- 2 With the FLIP COVER of the remote control open, press the MENU button to display the Advanced menu, then use the cursor ◀ / ▶ keys to select "COLOR".
- 3 Use the cursor ▼ / ▲ keys to select "COLOR TEMP".
- 4 Use the cursor ◀ / ▶ keys to select the "COLOR TEMP".
Four different types of color balance can be set beforehand: Low, Middle, Normal and High.

When the ENTER button is pressed, the sub-menu will be displayed to enable fine adjustment.

Setting the Video Type

- 1 With the FLIP COVER of the remote control open, press the MENU button to display the Advanced menu, then use the cursor ◀ / ▶ keys to select "COLOR".
- 2 Use the cursor ▼ / ▲ keys to select "VIDEO TYPE".
- 3 Use the cursor ◀ / ▶ keys to set the "VIDEO TYPE".
The following can be selected.
● DVD ● VCR
DVD is used for DVD players and Video is used for normal video players.

Selecting the Color System

The following color systems can be used with this unit.

- NTSC ● NTSC 4.43
- PAL ● PAL-M ● PAL-N ● PAL60
- SECAM

NOTE

- Only "NTSC" and "PAL" can be used for component video.
- Selection is automatic when "AUTO" is used.
- "AUTO" cannot be set for PAL-M and PAL-N input signals. Select "PAL-M" or "PAL-N" in "COLOR SYSTEM" menu for PAL-M and PAL-N input signals.

- 1 Select an input for the color system to be selected (page 20).
- 2 With the FLIP COVER of the remote control open, press the MENU button to display the Advanced menu, then use the cursor ◀ / ▶ keys to select "COLOR".
- 3 Use the cursor ▼ / ▲ keys to select "COLOR SYSTEM" and then press the ENTER button.
- 4 Use the cursor ▼ / ▲ keys to select the desired color system.

To close the menu
Press the R-CLICK/EXIT button.



Setting in Accordance With Image Content

Advanced Menu Settings (continued)

Setting the COMPUTER input terminal

The COMPUTER input terminal can be switched and used as the component video signal (YPbPr) input terminal.

- 1** With the **FLIP COVER** of the remote control open, press the **MENU** button to display the **Advanced menu**, then use the cursor **◀ / ▶** keys to select **“COLOR”**.
- 2** Use the cursor **▼ / ▲** keys to select **“SOURCE CHANGE”**.
- 3** Use the cursor **◀ / ▶** keys to set the **“SOURCE CHANGE”**.
The following can be selected.
● RGB ● YPbPr

Please select **“YPbPr”**.
When component video (YPbPr) input is used, use the optional component video cable.

Setting the Display Frame

The display frame can be set individually for each input.

- 1** Select the input for image selection (page 20).
- 2** With the **FLIP COVER** of the remote control open, press the **MENU** button to display the **Advanced menu**, then use the cursor **◀ / ▶** keys to select **“VIEW”**.
- 3** Display the frame, then use the cursor **▼ / ▲** keys to select **“ASPECT”**.
- 4** Use the cursor **◀ / ▶** keys to set the **“ASPECT”** ratio.
Any of the following four different settings can be selected for images.
● REAL (input signal projection without pixel replacement)
● AUTO (projection after automatic input signal zoom in/zoom out)
● DIRECT (the original aspect ratio of the image is maintained at all times)
● 4:3 → 16:9 (4:3 aspect ratio images are projected after conversion to 16:9 aspect ratio)

Setting Filter

This is used to set the sharpness during pixel conversion (image compression/enlargement and video playback).

- 1** With the **FLIP COVER** of the remote control open, press the **MENU** button to display the **Advanced menu**, then use the cursor **◀ / ▶** keys to select **“VIEW”**.
- 2** Display the frame, then use the cursor **▼ / ▲** keys to select **“FILTER”**.
- 3** Use the cursor **◀ / ▶** keys to set the sharpness.



To close the menu
Press the **R-CLICK/EXIT** button.

Initial Settings

Setting in Accordance With Image Content (continued)

Setting Keystone

This is used to set the height for keystone adjustment.

- 1 With the **FLIP COVER** of the remote control open, press the **MENU** button to display the **Advanced** menu, then use the cursor **◀ / ▶** keys to select **"VIEW"**.
- 2 Display the frame, then use the cursor **▼ / ▲** keys to select **"KEYSTONE"**.
- 3 Use the cursor **◀ / ▶** keys to select **"NORMAL"** or **"FULL"**.
 - Normal: Normal keystone correction

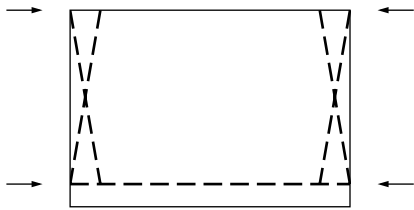

- Full: In this mode, the image is enlarged to fill the screen vertically and then Keystone correction is performed.

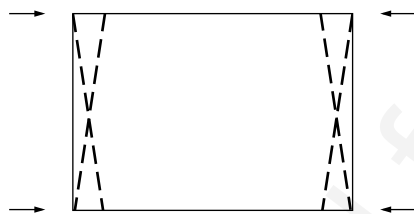

Setting the partial display position

Input a signal that is rated SXGA (XGA for the PG-M10S) to COMPUTER input terminal and then set the partial display position with "ASPECT" (see page 31) set to "REAL".

- 1 With the **FLIP COVER** of the remote control open, press the **MENU** button to display the **Advanced** menu, then use the cursor **◀ / ▶** keys to select **"VIEW"**.
- 2 Display the frame, use the cursor **▼ / ▲** keys to select **"PAN"** and then press the **ENTER** button.
- 3 Use the cursor **▼ / ▲**, **◀ / ▶** keys to set the display position.

Audio Muting

Audio only can be muted for each input. This function is convenient when multiple video units are connected to this unit.

- 1 Select the input to be muted (page 20).
- 2 With the **FLIP COVER** of the remote control open, press the **MENU** button to display the **Advanced** menu, then use the cursor **◀ / ▶** keys to select **"SETUP"**.
- 3 Use the cursor **▼ / ▲** keys to select **"SOUND MUTE"**, then use the cursor **◀ / ▶** keys to set muting to **"ON"** or **"OFF"**.

Selecting the Background

Two different backgrounds can be selected for projection when there is no signal input.

- 1 With the **FLIP COVER** of the remote control open, press the **MENU** button to display the **Advanced** menu, then use the cursor **◀ / ▶** keys to select **"SETUP"**.
- 2 Use the cursor **▼ / ▲** keys to select **"BACKGROUND"**.
- 3 Use the cursor **◀ / ▶** keys to select one of the following backgrounds.
 - Blue ● Black

Auto Gain

Brightness and contrast are adjusted automatically.

- 1 Select the input to be set for auto gain (page 20).
- 2 With the **FLIP COVER** of the remote control open, press the **MENU** button to display the **Advanced** menu, then use the cursor **◀ / ▶** keys to select **"SETUP"**.
- 3 Use the cursor **▼ / ▲** key to select **"AUTO GAIN"**, then use the cursor **◀ / ▶** keys to set **"ON"** or **"OFF"**.

To close the menu
Press the **R-CLICK/EXIT** button.

Setting the Menu (Option)

Selecting the Menu Language

Any one of eight different languages can be selected for menu displays.

- 1 With the **FLIP COVER** of the remote control open, press the **MENU** button to display the **Advanced** menu, then use the cursor **◀ / ▶** keys to select **“OPTION”**.
- 2 When **“OPTION”** menu is displayed, use the cursor **▼ / ▲** keys to select **“LANGUAGE”**, then press the **ENTER** button.
- 3 Use the cursor **▼ / ▲** keys to select one of the following languages.
 - English ● Swedish
 - German ● Spanish
 - French ● Chinese
 - Italian ● Japanese

Setting the Menu Display Position

The menu display position can be set with this function.

- 1 With the **FLIP COVER** of the remote control open, press the **MENU** button to display the **Advanced** menu, then use the cursor **◀ / ▶** keys to select **“OPTION”**.
- 2 When **“OPTION”** menu is displayed, use the cursor **▼ / ▲** keys to select **“MENU POSITION”** and then press the **ENTER** button.
- 3 Use the cursor **▼ / ▲**, **◀ / ▶** keys to set the display position.

Menu Viewing Settings

The menu viewing method can be set with this function.

- 1 With the **FLIP COVER** of the remote control open, press the **MENU** button to display the **Advanced** menu, then use the cursor **◀ / ▶** keys to select **“OPTION”**.
- 2 When **“OPTION”** menu is displayed, use the cursor **▼ / ▲** keys to select **“MENU TYPE”**.
- 3 Use the cursor **▼ / ▲**, **◀ / ▶** keys to select **“TRANSLUCENT”** or **“OPAQUE”**.

Other Menu Settings

The time that the menu is displayed on the screen can be set with this function.

- 1 With the **FLIP COVER** of the remote control open, press the **MENU** button to display the **Advanced** menu, then use the cursor **◀ / ▶** keys to select **“OPTION”**.
- 2 When **“OPTION”** menu is displayed, use the cursor **▼ / ▲** keys to select **“DISPLAY TIME”**.
- 3 Use the cursor **◀ / ▶** keys to set a value from **5 sec. to 30 sec.**

On-screen Display

This function is set to **“ON”** at the factory. When set to **“ON”**, input will be projected onto the screen when the input is switched with the remote control button. Also, the input menu will be displayed when the power is turned on to indicate the selected input. In addition, status is displayed on the menu bar when **“FREEZE”**, **“MUTE”**, **“ENLARGE”**, **“KEystone”** or **“VOLUME”** is set.

- 1 With the **FLIP COVER** of the remote control open, press the **MENU** button to display the **Advanced** menu, then use the cursor **◀ / ▶** keys to select **“OPTION”**.
- 2 When **“OPTION”** menu is displayed, use the cursor **▼ / ▲** keys to select **“ON SCREEN”**.
- 3 Use the cursor **◀ / ▶** keys to set **“ON”** or **“OFF”**.

To close the menu
Press the **R-CLICK/EXIT** button.



Troubleshooting

Please check the following before requesting repairs.

Problem	Check	Reference page
The power will not turn on.	<ul style="list-style-type: none"> Is the power plug connected to the power outlet? Is the lamp cover correctly installed? Is the internal temperature too high? A protective feature prevents the power turning on when the internal temperature is too high. Has the lamp usage time exceeded 1100 hours? The power will not turn on when 1100 hours have elapsed. 	18 37 36 29, 36, 37
No image	<ul style="list-style-type: none"> Has the connected input been selected? Are the cables correctly connected to the input terminals? Are the brightness and contrast set to minimum? Is the sliding lens cap closed? Is the lamp blown? Has the lamp usage time exceeded 1100 hours? If a notebook type computer is being used, was the computer power turned on after the projector was connected? Is the computer set to disable output to the external COMPUTER input terminal? In many cases, when a notebook type computer is connected to the projector, a signal will not be output to the COMPUTER input terminal unless the computer power is turned on. Does the STATUS indicator blink? 	18, 20 15, 16 26 18 37 29, 36, 37 16, 17 36
Distorted images	<ul style="list-style-type: none"> Is installation correct? Was the Keystone adjustment performed correctly? 	18 22, 32
Blurred images	<ul style="list-style-type: none"> Is the lens properly focused? Are the screen and projector positioned at the correct angle? Does the projection distance place the screen outside the focus range? Is there condensation, dirt, etc., on the lens? Condensation on the internal optical system is possible when the projector has been stored in a cool place and then is used in a warm place. In such cases, wait several minutes for the condensation to evaporate. Is the unit's input terminal set for RGB data while projecting PC data? 	19 18 13 — 31
Images are offset vertically or horizontally and are not correctly displayed	<ul style="list-style-type: none"> Correctly adjust the horizontal and vertical position of the screen. Is the clock frequency correctly adjusted? Are the resolution and frequency correct for the input signal? Check the resolution of the personal computer. 	28 28 27
The remote control does not work	<ul style="list-style-type: none"> Does the send indicator (LED) light? If it does not light, the batteries are exhausted. In such cases, replace with fresh batteries. Is there any obstacle between the remote control and the remote sensors of the main unit? Is the remote control being used outside its effective range? Is there a fluorescent light or other strong light source close to the remote sensors? 	9, 12 9 9 —
The wireless mouse control does not work	<ul style="list-style-type: none"> Is the MOUSE terminal of the main unit and the personal computer correctly connected? Was the personal computer started after being connected to the MOUSE terminal of the main unit? 	21 21
The STATUS indicator blinks	<ul style="list-style-type: none"> Check the STATUS indicator list. 	36
Flickering text or offset colors with COMPUTER input terminal	<ul style="list-style-type: none"> Manually adjust the clock frequency and phase. Press the AUTO SYNC button. 	28





When the STATUS Indicator Illuminates or Flashes

STATUS indicator

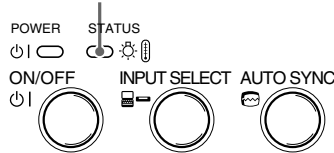

Status Light Messages

Condition	Status
OFF	Normal
On Continually	The lamp usage has exceeded 1000 hours of operation and should be replaced.
Flashing Very Rapidly (On and off in a cycle of 1 sec.)	<ul style="list-style-type: none"> The lamp cover is not correctly attached. Replace it correctly.
Flashing Rapidly (On and off in a cycle of 4 sec.)	<ul style="list-style-type: none"> The temperature protector has been triggered. If the room temperature is high, move the unit to a cool location. If the temperature within the unit is high, check the cooling fan (exhaust vent) and the cooling fan (exhaust vent) on the bottom of the unit. If any of the slots are blocked, remove whatever is blocking them. The temperature protector has been triggered. If you try to turn on the unit immediately after turning off, sometimes the power does not come on. If this happens, wait at least one minute, then turn on the unit again. The lamp lighting voltage error detection protector has been triggered. Wait at least one minute before turning on the unit again. If this does not solve the problem, please contact your dealer.
Flashing Slowly (On and off in a cycle of 8 sec.)	The cooling fan has stopped. Contact your Sharp Authorized LCD Projector Dealer or Service Center.
Flashing Very Slowly (On and off in a cycle of 12 sec.)	<p>The lamp is not turned on.</p> <ul style="list-style-type: none"> The unit was turned on immediately after being turned off. Turn off the unit, wait at least one minute, then turn on the unit again. The lamp is dead. Replace the lamp cage. (See page 37.)





Replacing the Projection Lamp

CAUTION:

- Potential hazard of glass particles if lamp has ruptured. Please have Sharp Authorized LCD Projector Dealer or Service Center replace lamp if rupture occurs.
- Do not remove the lamp cage directly after operation of the projector. The lamp may be extremely hot. Wait at least one hour after the power cord is disconnected to allow the surface of the lamp cage to fully cool before removing the lamp cage.

The rated lamp life is about 1000 hours. The rated lamp life is the average life of the lamps produced and tested (under the test conditions of our company). However, it may become shorter depending on the conditions of usage. After the lamp has been operating for 1000 hours or longer, the STATUS indicator on the control panel will light and the "LAMP USAGE" icon which shows hours of total lamp usage will be displayed on the screen. When this happens, turn off the unit and replace the lamp cage with a new one. The unit will not turn on after 1100 hours. (It will go off if it is in use.)

Removing and installing the lamp unit

CAUTION

- Be sure to remove the lamp cage by the handle. Be sure not to touch the glass surface of the lamp cage or the inside of the projector.
- Do not loosen any screws except for those mentioned in the instructions below. There is danger of electric shock.
- To avoid injury to yourself and damage to the lamp, be sure to carefully follow the steps below.

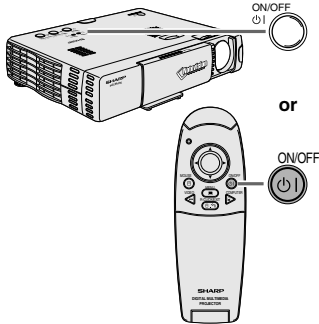
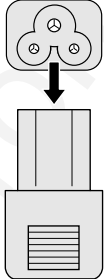
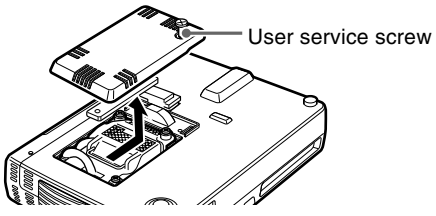
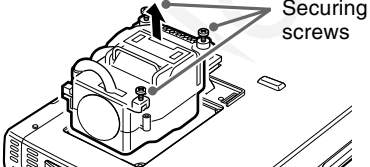
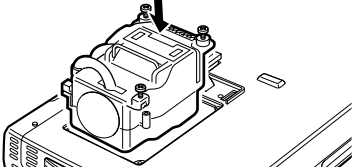
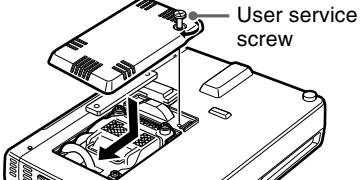
<p>1 Turn off the power.</p> <p>Press the POWER ON/OFF button. Wait until the cooling fan stops.</p> 	<p>2 Disconnect the power cord.</p> <p>Unplug the power cord from the AC socket. Wait at least one hour after power cord is disconnected.</p> 	<p>3 Open the lamp cage cover.</p> <p>Turn over the projector and unfasten the user service screw that secures the lamp cage cover. Then open the cover in the direction of the arrow.</p> 
<p>4 Remove the lamp cage.</p> <p>Unfasten the three securing screws on the lamp cage. Hold the lamp cage by the handle and pull it upward.</p> 	<p>5 Replace the lamp cage (after changing the lamp).</p> <p>Press the lamp cage firmly into the lamp cage compartment. Fasten the securing screws.</p> 	<p>6 Close the lamp cage cover.</p> <p>Close the lamp cage cover in the direction of the arrow. Then fasten the user service screw.</p> 

NOTE

- Reset the lamp usage timer after replacing the lamp. See page 29 for information.

NOTE

- When the lamp usage timer reaches 1100 hours, it becomes impossible to turn on the power and menus are not displayed. In such a case, see "When the lamp usage timer has exceeded 1100 hours and the unit will not turn on" on page 29.
- Obtain a replacement lamp cage at the store where the unit was purchased. Please specify the following information when ordering a replacement lamp cartridge:
 - Model name : BQC-PGM10X// -1





Transporting the Projector

When transporting the unit, please slide the lens cap to the closed position and utilize the supplied carrying bag. Avoid strong vibration and physical shock during transportation.

Using the Carrying Bag

A soft-side carrying bag is provided to transport the unit. Before placing the projector into the carrying bag, set up the inner pad inside the bag as shown.

How to use the carrying bag

Packing the unit

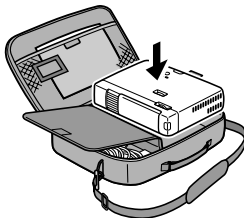

Packing the accessories



CAUTION

- The supplied carrying bag is made exclusively for the unit and its supplied accessories. Do not place other items into the carrying bag with the unit or use the bag to transport items other than the unit and its accessories.
- This bag is provided merely to transport the unit and its accessories, not to protect these products from damage as a result of rough handling. When carrying the unit around, please use the carrying bag that comes with it and, to protect lens from scratches, always shut the sliding lens cap. Do not expose these products to shocks or impact when transported in the carrying bag.
- Always carry the unit in the carrying bag. Ensure that the power cord and other cables connecting to video sources are disconnected before moving the unit. When moving the unit or when it is not in use, cover the lens with sliding lens cap.
- Wait until the unit has sufficiently cooled before placing it into the carrying bag. If the unit is placed into the bag while it is still hot, the heat may damage the bag lining.

Attaching the shoulder strap to the carrying bag

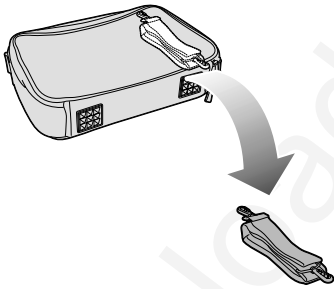
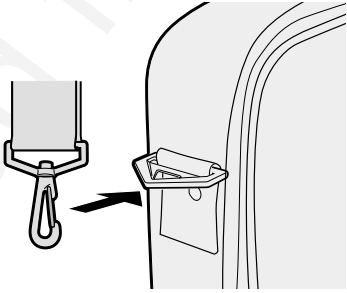
<p>1 Take the shoulder strap out.</p>	<p>2 Fasten the shoulder strap to the carrying bag.</p>
<p>The shoulder strap is stored in the pocket located in front of the carrying bag.</p> 	 <p>Follow the same procedure for the other end of the strap.</p>





Specifications

Product type	Digital Multimedia Projector
Model	PG-M10X/PG-M10S
Video system	NTSC/NTSC4.43/PAL/PAL M/PAL N/PAL60Hz/SECAM
Display method	Single Chip Digital Micromirror Device™ (DMD™) by Texas Instruments
DMD panel	Panel size: 21.8 mm (0.7"), 1 chip XGA DMD/PG-M10X, 1 chip SVGA DMD/PG-M10S No. of dots: 786,432 dots (1,024 [H] × 768 [V])/PG-M10X, 480,000 dots (800 [H] × 600[V])/PG-M10S
Lens	Manual focus fixed lens, F3.0, f = 23 mm
Projection lamp	High Performance Compact lamp, DC130W
Contrast ratio	800:1
Video input signal	RCA Connector: VIDEO, composite video, 1.0 Vp-p, sync negative, 75 Ω terminated 3.5 φ mini jack: AUDIO, 0.4 Vrms more than 47 kΩ (stereo)
S-video input signal	4-pin mini DIN connector Y (luminance signal): 1.0 Vp-p, sync negative, 75 Ω terminated C (chrominance signal): Burst 0.286 Vp-p, 75 Ω terminated
Horizontal resolution	500 TV lines (video input)
Audio output	0.5 W (monaural)
Computer RGB input signal	15-PIN MINI D-SUB CONNECTOR: RGB separate/sync on green type analog input: 0–0.7 Vp-p, positive, 75 Ω terminated 3.5 φ MINI JACK: AUDIO, 0.4 Vrms, more than 47 kΩ (stereo) HORIZONTAL SYNC. SIGNAL: TTL level (positive/negative) VERTICAL SYNC. SIGNAL: Same as above
Pixel clock	12–157 MHz
Vertical frequency	50–85 Hz
Horizontal frequency	15–91 kHz
Speaker system	3.5 × 2 cm (1 3/8" × 13/16") oval
Rated voltage	AC 110–120/220–240 V
Input current	1.0 A/1.9 A
Rated frequency	50/60 Hz
Power consumption	180 W (PG-M10X/PG-M10S)
Operating temperature	41°F to 95°F (+5°C to +35°C)
Storage temperature	14°F to 140°F (–10°C to +60°C)
Cabinet	Magnesium alloy (Terminal panel, Lamp cover and side vent cover constructed of plastic)
I/R carrier frequency	38 kHz
Dimensions (approx.)	230 (W) × 48 (H) × 177 (D) mm (9 1/8" × 1 7/8" × 6 15/16") (main body only) 231 (W) × 61 (H) × 177 (D) mm (9 1/8" × 2 3/8" × 6 15/16") (including adjustment feet and projecting parts)
Weight (approx.)	1.4 kg (3.1 lbs.)
Supplied accessories	Remote control, Two AAA size batteries, Power cord for Americas (1.8 m, 5' 15/16"), Power cord for Europe (1.8 m, 5' 15/16"), Power cord for Australia, New Zealand and Oceania (1.8 m, 5' 15/16"), Power cord for U.K., Hong Kong and Singapore (1.8 m, 5' 15/16"), Computer RGB cable (1 m, 3' 3"), Audio cable (1 m, 3' 3"), Audio adapter (15 cm, 6 45/64"), USB mouse control cable (1 m, 3' 3"), PS/2 mouse control cable (1 m, 3' 3"), Video cable (1 m, 3' 3"), S-Video cable (1 m, 3' 3"), Soft pouch, Carrying bag, Projector operation manual, Projector quick reference
Replacement parts	Remote control (9FU770823300), Two AAA size batteries (9FU770702000), Power cord for Americas (9FU770726000), Power cord for Europe (9FU770727000), Power cord for Australia, New Zealand and Oceania (9FU770729000), Power cord for U.K., Hong Kong and Singapore (9FU770728000), Computer RGB cable (9FU770708000), Audio cable (9FU770710000), Audio adapter (9FU770704000), USB mouse control cable (9FU770707000), PS/2 mouse control cable (9FU770706000), Video cable (9FU770703000), S-Video cable (9FU770709000), Soft pouch (9FU770823400), Carrying bag (9FU770823200), Projector operation manual (9FU770822800), Projector quick reference (9FU770822900), Replacement lamp (BQC-PGM10X/-1)

This SHARP projector uses a DMD panel. This very sophisticated panel contains 786,432 (PG-M10X)/480,000 (PG-M10S) pixels. As with any high technology electronic equipment such as large screen TVs, video systems and video cameras, there are certain acceptable tolerances that the equipment must conform to.

This unit has some inactive pixels within acceptable tolerances which may result in inactive dots on the picture screen. This will not affect the picture quality or the life expectancy of the unit. If you have any questions about this matter, please call toll free 1-888-GO-SHARP (1-888-467-4277). [\[U.S.A. ONLY\]](#)

Specifications are subject to change without notice.



D-Sub Pin Assignments

PC 15-Pin mini D-Sub

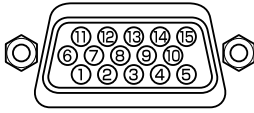

Pin No.	Signal to be connected
1	Red
2	Green
3	Blue
4	GND
5	GND
6	Red GND
7	Green GND
8	Blue GND
9	No Connection
10	Digital GND
11	GND
12	SDA
13	Horizontal Sync
14	Vertical Sync
15	SCL

Dimensions

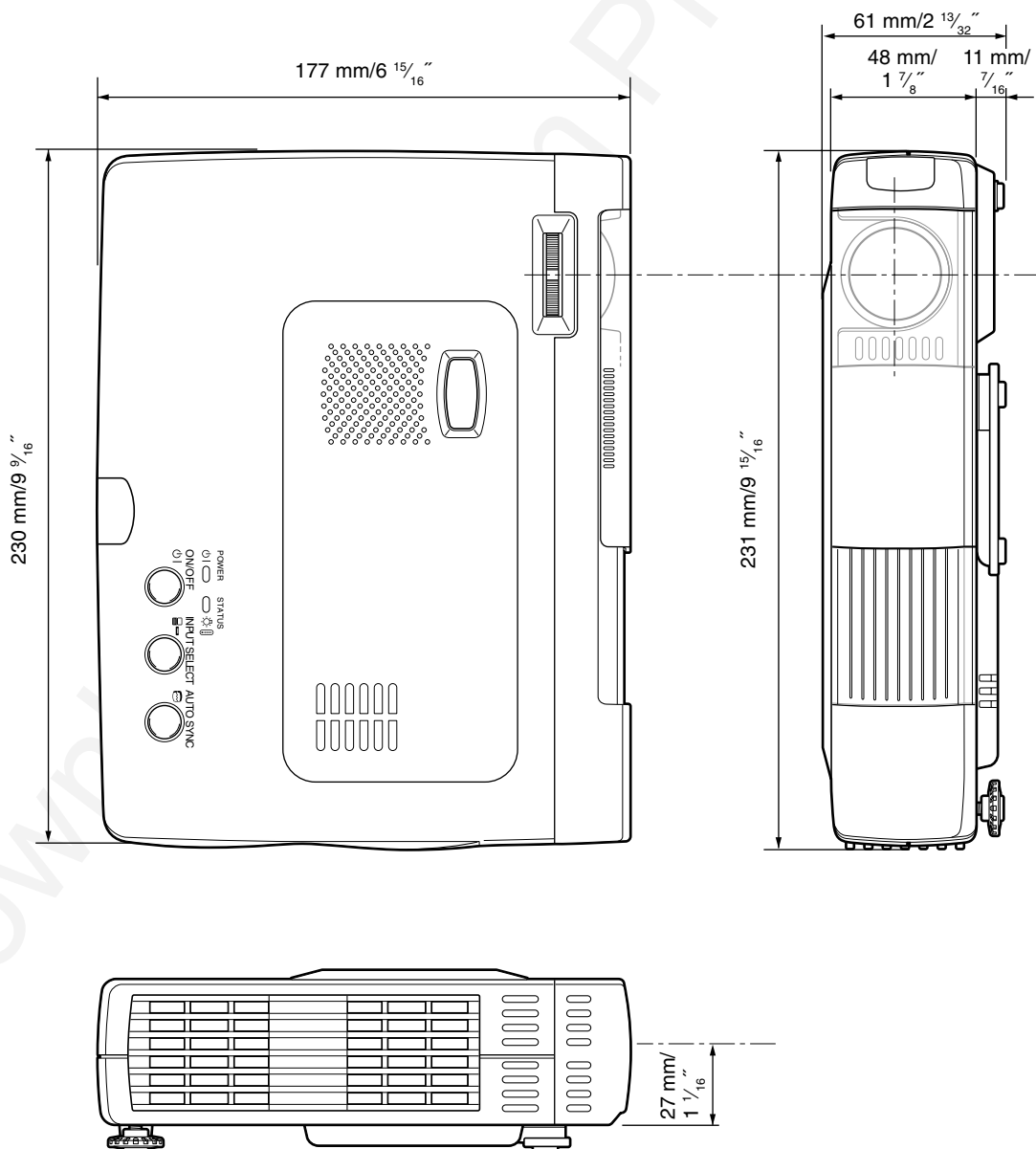



Guide to Effective Presentations

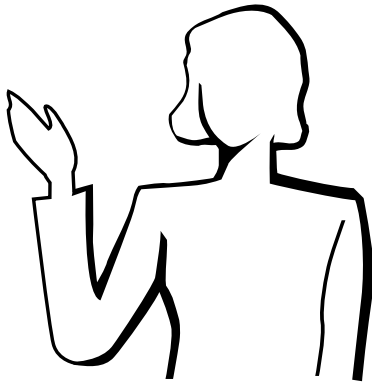

Electronic presentations are one of the most effective tools presenters can use to persuade an audience. There are several ways to enhance your presentation and maximize your effectiveness. The following are guidelines to help you create and deliver a dynamic presentation.

a. Types of Presentations

Computer Presentations

- To present basic information such as graphs, spreadsheets, documents and images, use word processing and spreadsheet applications.
- To convey more complex information and create more dynamic presentations which allow you to control the pace of your delivery, utilize software such as Astound®, Freelance®, Persuasion® or PowerPoint®.
- For high-end multimedia and interactive presentations, use software such as Macromedia Director®.

NOTE

- Astound®, Freelance®, Persuasion®, PowerPoint® and Macromedia Director® are trademarks of their respective companies.

Video Presentations

Use of video equipment, such as a VCR, DVD player and laser disc player, can be effective for delivering instructional or illustrative information that is difficult to present.

Digital Cameras and Personal Digital Assistants (PDAs)

For highly compact and portable presentations, still cameras, digital video cameras, document cameras and PDAs are ideal for transferring data without cumbersome conversions.

Multimedia Presentations

You can integrate all of the above methods for a full multimedia presentation including video, audio, computer applications and World Wide Web information.

b. Creative Presentations

Oftentimes presenters do not take advantage of the many subtle ways they can manipulate their electronic slides to more effectively persuade the audience.

Color has a great effect on the audience during a presentation. When used correctly and legibly, studies show that background & foreground colors establish an emotional tone for a presentation, help viewers understand and retain information, and influence an audience to take a desired course of action.

Color Considerations

- Choose legible colors.
- Text and graphics colors need sufficient contrast.
- Use darker colors for the background since a lighter background can create uncomfortable glare. (Yellow on black creates an ideal contrast.)

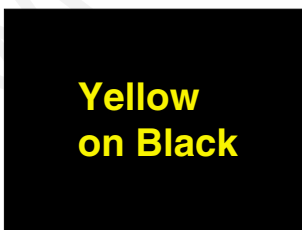
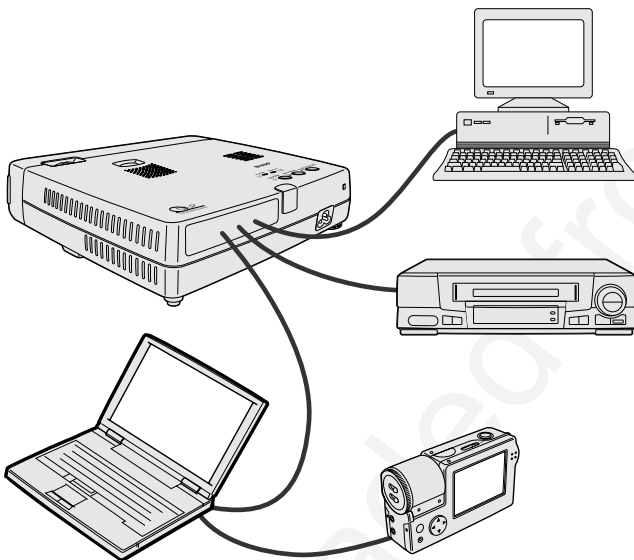
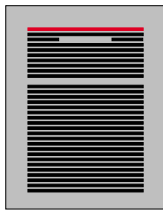
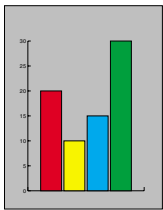

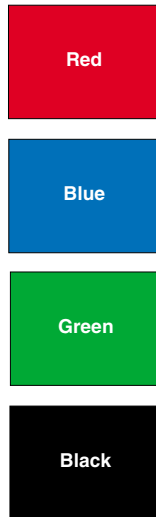

- Background colors can subconsciously affect the audience:

Red—increases viewers' pulse and breathing and encourages risk taking but can also be associated with financial loss.

Blue—has a calming and conservative affect on the audience but can also create boredom among corporate audiences that are often inundated with this background color.

Green—stimulates interaction.

Black—conveys finality and certainty. Use it as a transitional color between slides when moving from one idea to another.

- Foreground colors create a major impact on how well an audience understands and remembers a message.
 - Use one or two bright colors for emphasis.
 - Highlight important messages.
- The eye has a difficult time reading certain colored text on certain colored backgrounds. For example, text and background colors in red and green, and blue and black make for difficult viewing.
- Colorblind individuals may find it difficult to distinguish between red and green, brown and green, and purple and blue. Avoid using these colors together.

Fonts

- One of the most common mistakes in any type of presentation visual is the selection of type fonts that are too small, too thin, or too difficult to read.
- If you are not sure how well a given font will read on a screen at various sizes, try this: Draw a 6" x 8" box on a piece of paper and print out several lines of text inside the box with your computer printer at 300 or 600 dpi resolution. Vary the sizes of text to simulate headline, body and text call-outs for any charts or graphs. Hold the printout at arm's length. This is how your text will look on a 4' (1.2 meters)-wide screen at 10' (3 meters), on a 7.5' (2.3 meters)-wide screen at 20' (6.1 meters) and a 12' (3.7 meters)-wide screen at 30' (9.1 meters). If you cannot read the text easily, you should put less copy on your visuals or use larger typefaces.
- Design your visuals so that they are visible by the viewer in the last row.
- Nothing will ruin your presentation faster than misspelled words. Take the time to proofread and edit your work before your visuals become a permanent part of your presentation.
- Mixed case text is easier to read than text which is displayed in capital letters.
- Another important attribute of fonts is whether any particular face is serif or sans-serif. Serifs are small, usually horizontal cross strokes that are added to the end of a letter's main strokes. Because of their ability to coax the eye along the line of type, fonts with serifs are generally acknowledged to be more readable.

Sans-serif
Serif



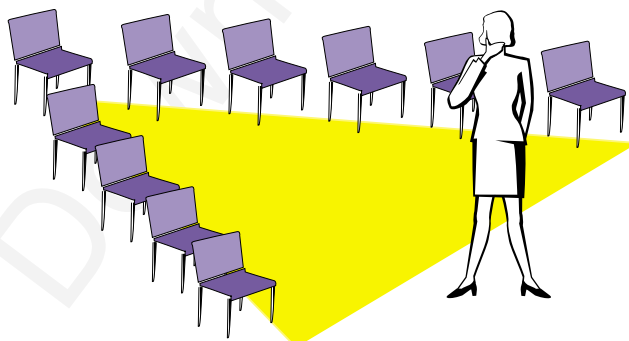
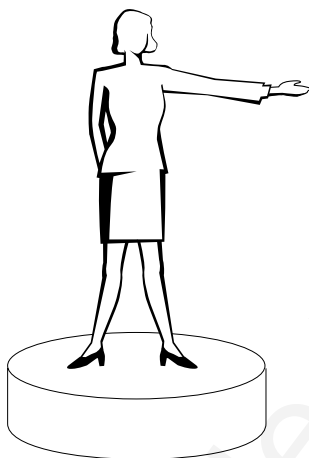
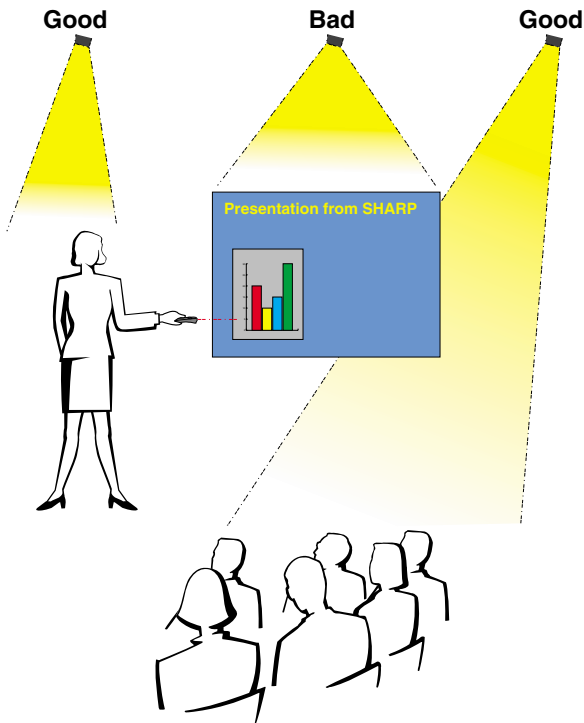

c. Set-Up

When giving a presentation, you need to set the stage both figuratively and literally for success. The way you set up a presentation room will have a great impact on the audience's perception of you and your message. By manipulating the placement and use of the following tools, you will improve the impact of your presentation.

Lighting—Good lighting is an important component of a successful presentation. You should strive to create an unequal distribution of light. An audience should always see as much of the presenter's face as possible, so most of the light should be focused on you. Because it is important for you to be able to read the audience's faces and body language, some light should be shed upon them. However, no light should shine on the screen.

Stage—When presenting on the same level surface that your audience is on, most people can only see the top one-third of your body. Therefore, it is recommended that when giving a presentation to an audience of 25 or more, you stand on a stage or platform. As more of your body is visible, the easier it is to communicate with an audience.

Podiums—The best presenters avoid podiums because they hide 75% of the body and restrict movement. However, many people feel more comfortable with a podium to hold their notes and hide their discomfort. If you must use a podium, angle it at 45 degrees to the audience so that you are not completely hidden.

Visuals—It is imperative that you make sure your visuals are large enough and projected far enough for the audience to see. Eight times the height of an image is the optimal viewing distance to read 24 point type. The bottom of a screen should be at least 6' (1.8 meters) above the floor.

Screen—The screen should always be in the center of the room so that all audience members can see it. Because people read from left to right, you should always stand to the audience's left when discussing visuals.

Seating—Arrange seating according to the dynamics of your presentation. If the presentation is more than half-a-day, use classroom style seating—a chair and a desk. If you would like to encourage audience interaction, use chevron seating, angling the chairs into a "V" shape. When you have a very small audience, a "U" shaped arrangement will increase interchange.





d. Rehearsing & Delivery

- The best time to rehearse is the day or evening before, not a couple of hours before, and the best place to rehearse is in the actual room. Rehearsing a speech in a small office is not the same as standing up in front of 100 people in a hotel ballroom or classroom.
- Due to varying processor speeds of computers, practice your slide transitions for proper timing.
- Whenever possible, set up your equipment well in advance to allow adequate time to resolve any unexpected issues such as lighting, power, seating and audio.
- Thoroughly check every piece of equipment you bring along. Make sure you have fresh batteries in your remote controls and laptop computer. Fully charge your computer's battery before the presentation and connect your AC adaptor for added safety.
- Make sure you are completely familiar with the control panel on your projector and remote controls.
- If you are using a microphone, check it out before hand and walk around to see where you might have problems with feedback. Avoid standing in these problem areas during your presentation.

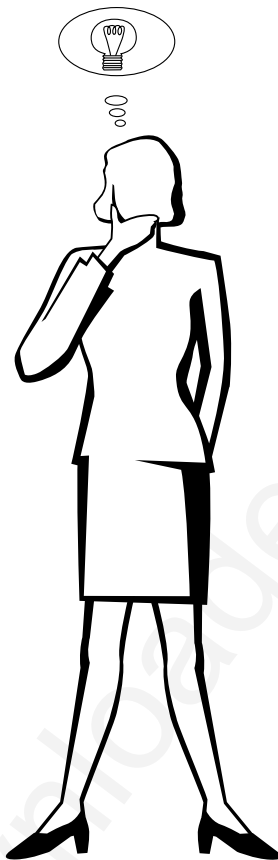

e. Presentation Tips

- Before beginning, visualize yourself delivering an outstanding presentation.
- Know your speech, memorizing at least the first three minutes of your presentation will allow you to focus on your rhythm and pacing.
- Speak to early arrivals to help you build a rapport with the audience and make you feel more comfortable.
- Do not be overly dependent on your visuals by reciting what your audience is already reading. Know your material well enough to be able to deliver the presentation with ease. Use your visuals to emphasize keypoints.
- Be sure to project your voice clearly and use eye contact to maintain audience attention.
- Do not wait until halfway through your presentation to get your point across. If you wait and try to create a "build-up", you may lose some of your audience along the way.
- Keep your audience's attention. As most people only focus for 15 to 20 minutes during a one-hour presentation, it is important to recapture their attention periodically. Use phrases like, "This is critical to my point" or "This is absolutely fundamental" to remind them you are saying something they need to hear.



Active Digital keystone correction

Function to digitally correct a distorted image when the projector is set up at an angle.

- Not only does the projector feature anti-aliasing and left-right compression but also up-down compression, maintaining the aspect ratio of 4:3 even if the viewing angle changes.

Aspect

The display frame can be set individually for each input.

1. REAL Input signal projection without pixel replacement
2. AUTO Projection after automatic input signal zoom in/zoom out
3. DIRECT The original aspect ratio of the image is maintained at all times
4. 4:3 → 16:9 4:3 aspect ratio images are projected after conversion to 16:9 aspect ratio

Auto gain

Brightness and contrast are adjusted automatically.

Auto power off

When there is no signal input for a period of 5 minutes or more, the power is automatically turned off and standby status is activated.

Auto source

Automatically searching the input signal.

Auto sync

Optimizes projected computer images by automatically adjusting certain characteristics.

Background

Two different backgrounds can be selected for projection when there is no signal input.

Clock

Clock adjustment is used to adjust vertical noise when clock level is incorrect.

Color temp.

Color temperature function can be used to adjust the color temperature to suit the type of image input to the projector.

Decrease the color temperature to create warmer, reddish images for natural flesh tones. Increase the color temperature to create cooler, bluish images for a brighter picture.

Compatibility

Ability to use with various image signal modes.

DMD

Digital Micromirror Device™ (DMD™) by Texas Instruments.

Enlarge

Digitally zooms in on a portion of an image.

Filter

This function is used to set the sharpness during pixel conversion (image compression/enlargement).

Freeze

Function to freeze a moving image

Gamma

Image quality enhancement function that offers a richer image by brightening the darker portions of the image without altering the brightness of the brighter portions.

Intelligent compression and expansion

High quality resizing of lower and higher resolution images to fit the projector's native resolution.

Menu type

The menu viewing method can be set with this function.

Phase

Phase shift is a timing shift between isomorphic signals with the same resolution. When phase level is incorrect, the projected image typically displays horizontal flicker.

Startup image

The image displayed when the projector is turned on.

Sync

Synchronizes the resolution and phase shift of two signals. When receiving an image with a resolution different from that of the computer, the projected image may be distorted.

Sync on green

Video signal mode of a computer which overlaps horizontal and vertical sync signal to green color signal pin.

Wireless mouse

Function to operate the mouse control of a computer with the supplied remote control.



A	
AC socket	18
ASPECT ratio	31
Audio adjustments	22
Audio cable	8
AUDIO input terminal	15
AUTO GAIN setting	32
AUTO POWER OFF setting	33
AUTO SOURCE setting	33
AUTO SYNC adjustment	22
AUTO SYNC button	10, 12
AV MUTE button	12
B	
BACKGROUND setting	32
C	
Carrying bag	8, 38
Clock	28
COLOR TEMP. (Color balance) setting	30
COMPUTER button	20
COMPUTER input terminal	16
Computer RGB cable	8
Control panel	10
Cooling fan (Exhaust vent)	10
Cursor key	12
D	
DISPLAY TIME setting	34
E	
ENLARGE button	12, 23
ENTER button	12, 21
EXIT button	12
F	
FILTER setting	31
Flip cover	12
Focus ring	19
Foot release	19
Foot release button	19
FREEZE button	22
G	
GAMMA setting	30
H	
High mount projection	14
I	
INPUT SELECT button	10, 18, 20
K	
Kensington Security Standard connector	11
KEYSTONE button	12
KEYSTONE setting	32
L	
Lamp cage cover	37
Lamp cover screw	37
LEFT-CLICK button	12, 21
Lens	13
M	
MENU button	12, 24
MENU TYPE setting	34
MOUSE buttons	12, 21
Mouse control cable for USB	21
Mouse control cable PS/2	21
MOUSE terminal	21
O	
On-screen menu language	34
ON SCREEN setting	34
P	
Phase	28
POWER ON/OFF button	10, 18, 20
Power cord	8
POWER indicator	10, 18, 20
R	
Rear adjuster	19
Rear projection	14
Remote control	9
Remote control sensor	9
Remote control signal transmitter	9, 12
RIGHT-CLICK button	12, 21, 26
S	
Signal type	20
Sliding lens cap	18
SOUND MUTE setting	32
SOURCE CHANGE setting	31
Speaker	10, 15, 22
STATUS indicator	36
S-VIDEO input terminal	11, 15
T	
Terminal Panel	11, 15
V	
VIDEO button	12, 20
VIDEO input terminal	11, 15
VIDEO TYPE setting	30
VOLUME button	12, 22
W	
Wireless mouse	21

SHARP®
SHARP CORPORATION

Downloaded from projector.com

PLEASE READ

This manual is provided as a free service by Projector.com.

We are in no way responsible for the contents of the manual. We do not guarantee its accuracy and we do not make any claim of copyright. The copyright remains the property of their respective owners.

ABOUT PROJECTOR.COM

Projector.com (<http://www.projector.com>) is your review and buying guide resource for DLP and LCD video projectors.

Visit the site to read the latest projector news and reviews, read and comment on projector specifications, download user manuals and much more.